

PLUMBING L-STEMS

BYSON



www.byson-intl.com



Product

Application

OEM Se

Byson is a group of faucet and plumbing manufacturing

Show you the best of mine

[Read more](#)

W60101

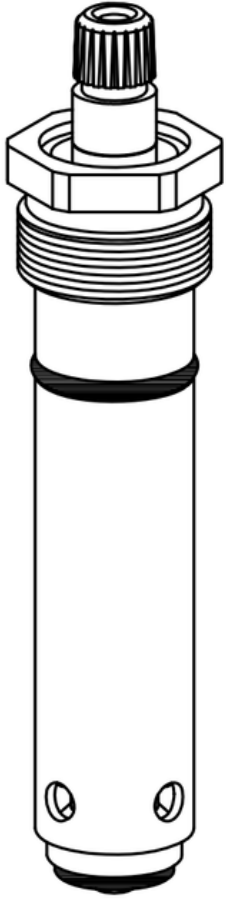

AM.STANDARD 4-1/2"
DIVERTER

W60171

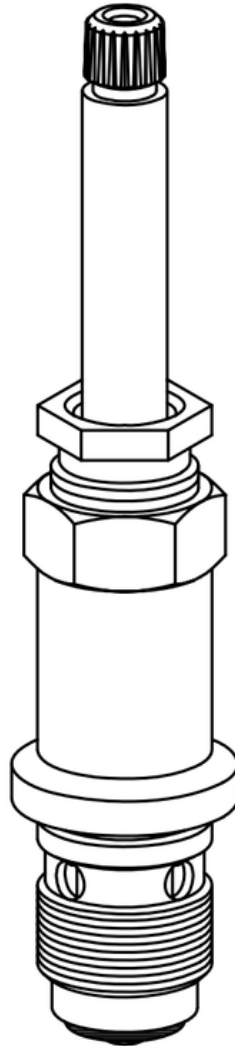

AM.STANDARD 5-15/16"
DIVERTER
WITH C.P (1)

W60173

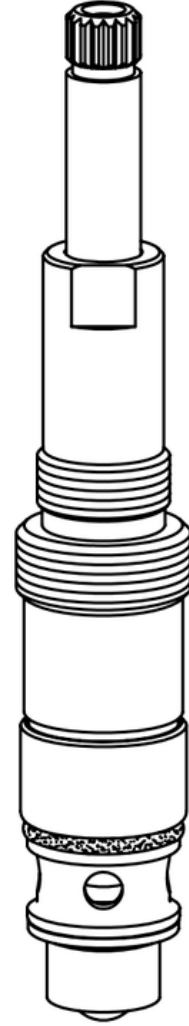

AM.STANDARD 5"
DIVERTER

W60170

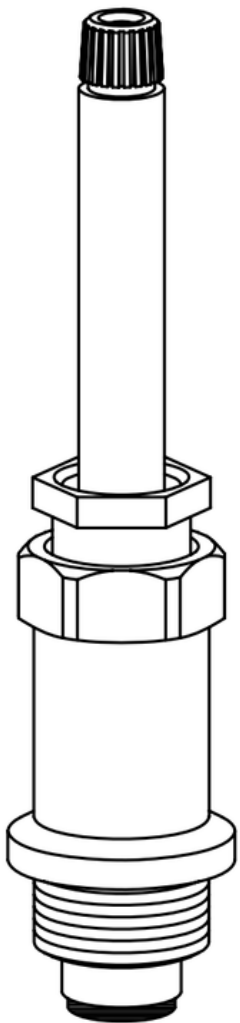

AM.STANDARD 5-1/4"
HOT/COLD
WITH C.P (1)

W60172

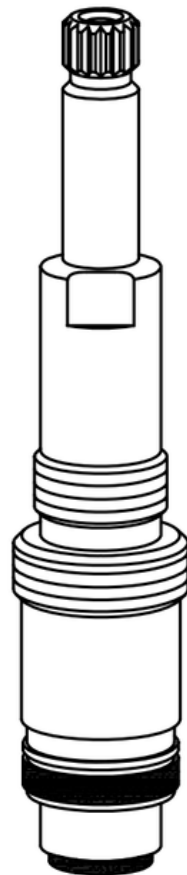

AM.STANDARD 4-1/2"
HOT/COLD

W60174

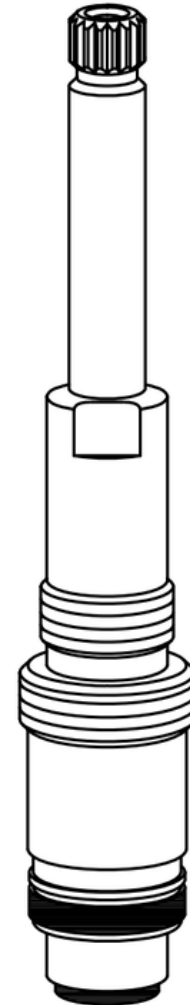

AM.STANDARD 5"
HOT/COLD

W60175

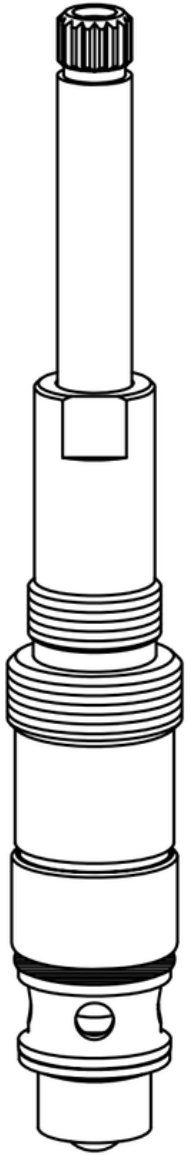

AM.STANDARD 5-3/4"
DIVERTER

W60177

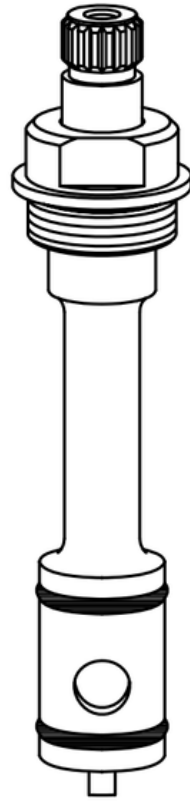

AMERICAN BRASS 3-15/16"
DIVERTER

W60182

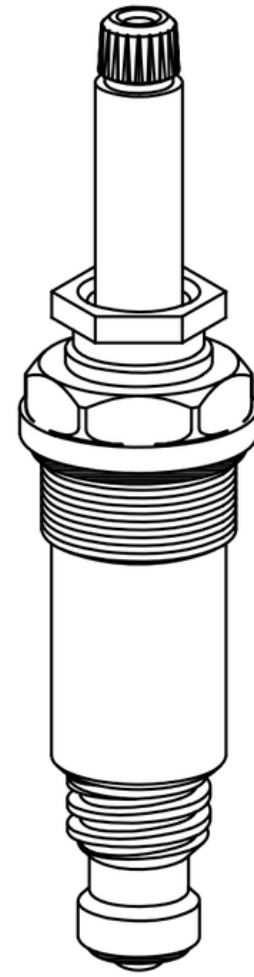

AM.STANDARD 5"
HOT
WITH C.P (1)

W60176

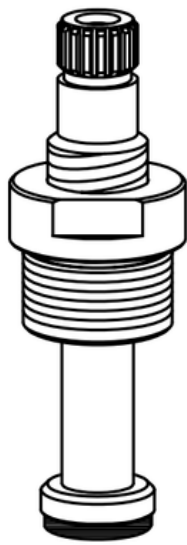

AMERICAN BRASS 2-21/32"
HOT/COLD

W60178

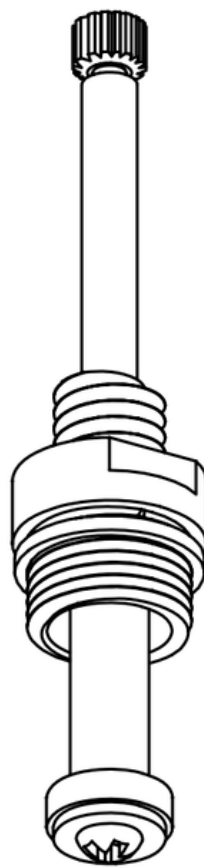

HOT

W60183

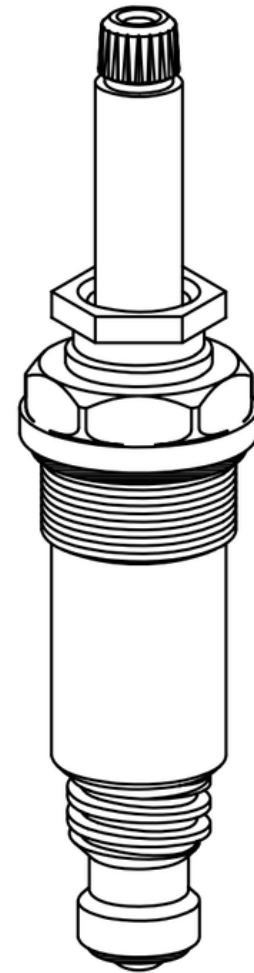

AM.STANDARD 5"
COLD
WITH C.P (1)

W60184

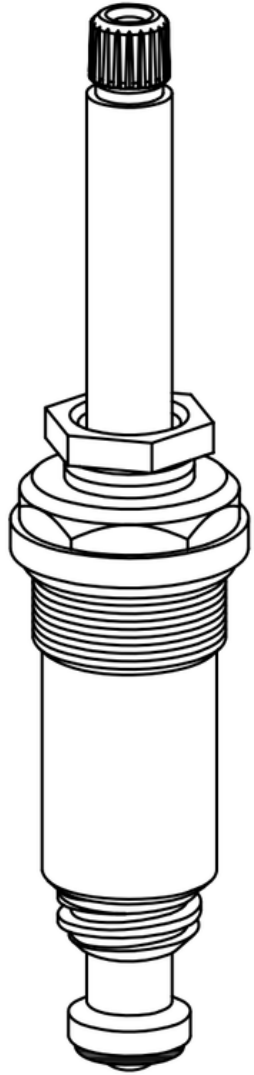

AM.STANDARD 5-3/8"
HOT
WITH C.P (1)

W60186

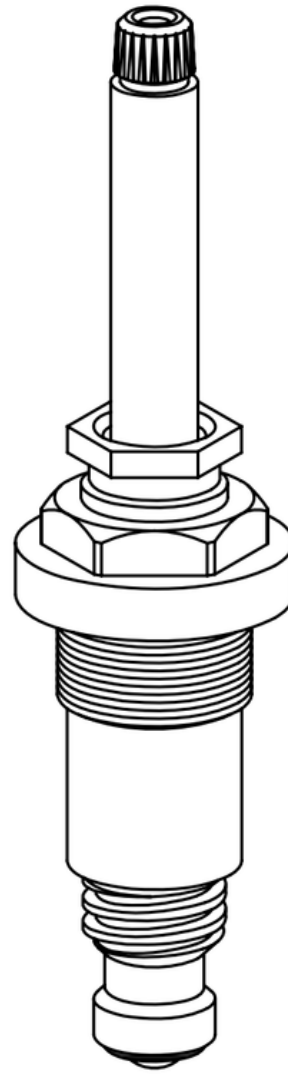

AM.STANDARD 5-15/32"
HOT/COLD
WITH C.P (1)

W60192

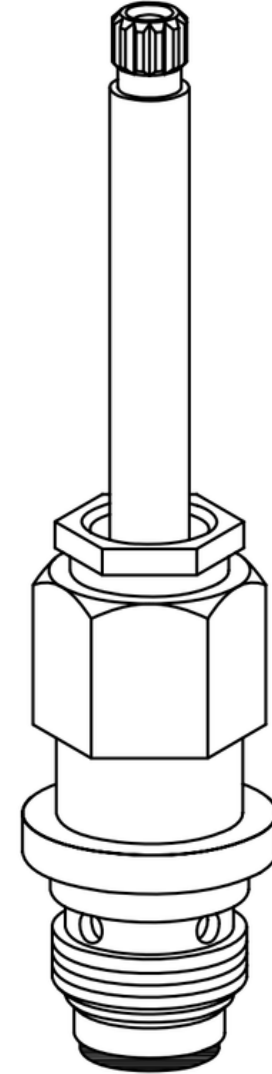

ARROWHEAD BRASS 5-1/2"
DIVERTER
WITH C.P (1)

W60185

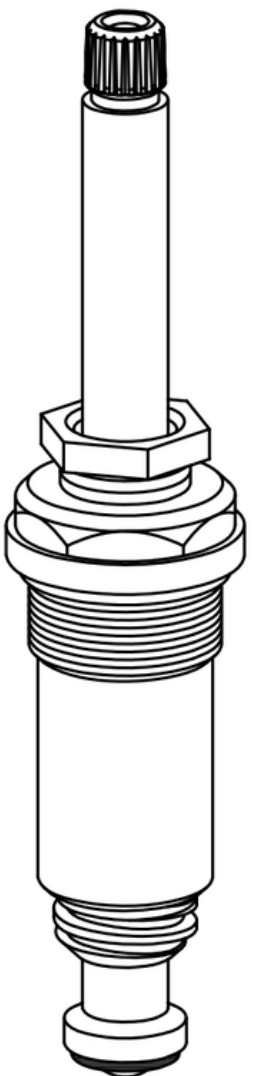

AM.STANDARD 5-3/8"
COLD
WITH C.P (1)

W60191

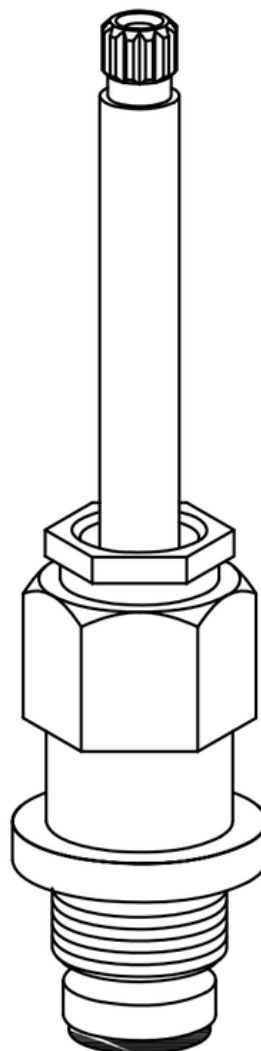

ARROWHEAD BRASS 5-1/4"
HOT/COLD
WITH C.P (1)

W60240

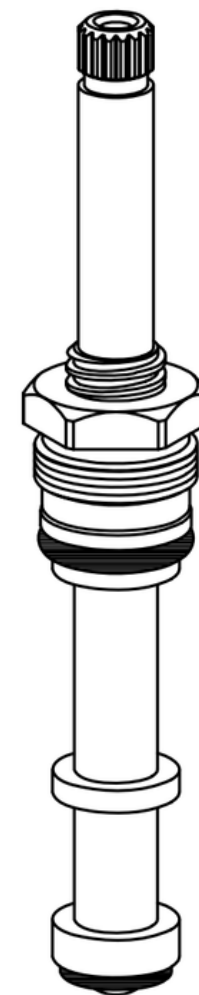

BARNES 5"
HOT/COLD

W60250



18 PT.

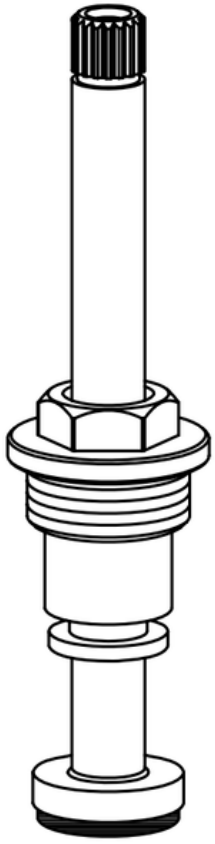

BRIGGS 4-1/2"
HOT

W60252



18 PT.

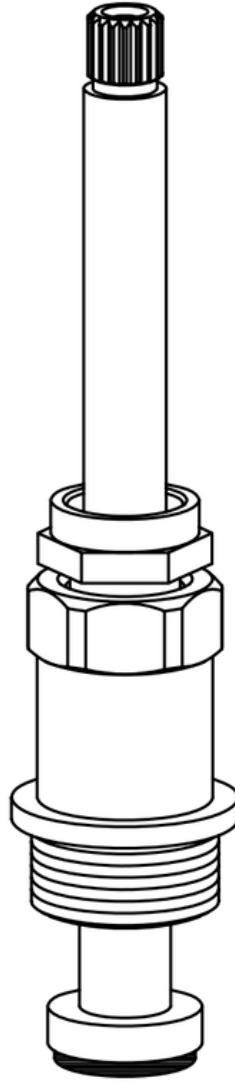

BRIGGS 5-1/2"
HOT/COLD
WITH C.P (1)

W60255



18 PT.

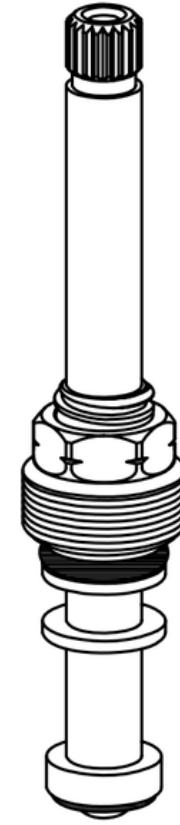

BRIGGS 4-1/2"
COLD

W60251



18 PT.

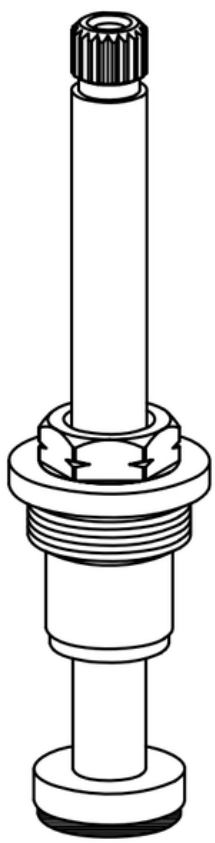

BRIGGS 4-1/2"
COLD

W60254



18 PT.

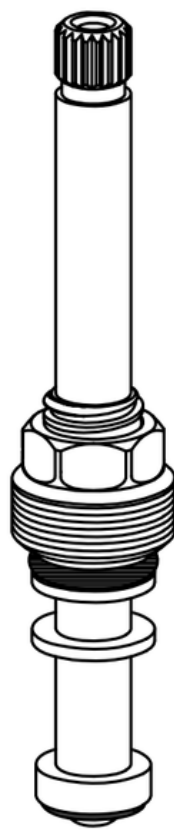

BRIGGS 4-1/2"
HOT

W60256



18 PT.



BRIGGS 5"
DIVERter

W60257



17 PT.

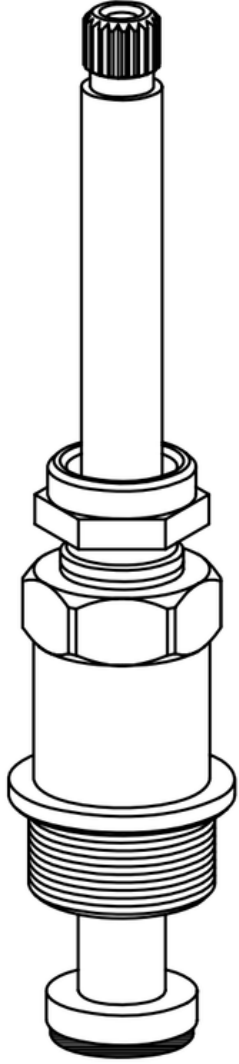

BRIGGS 5-1/2"
HOT/COLD

W60260



18 PT.

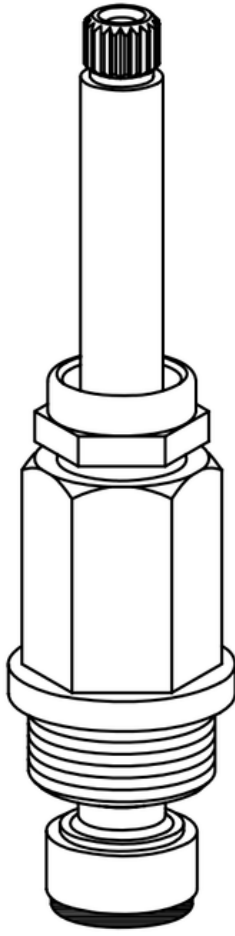

BRIGGS 4-5/8"
HOT
WITH C.P (1)

W60262



18 PT.

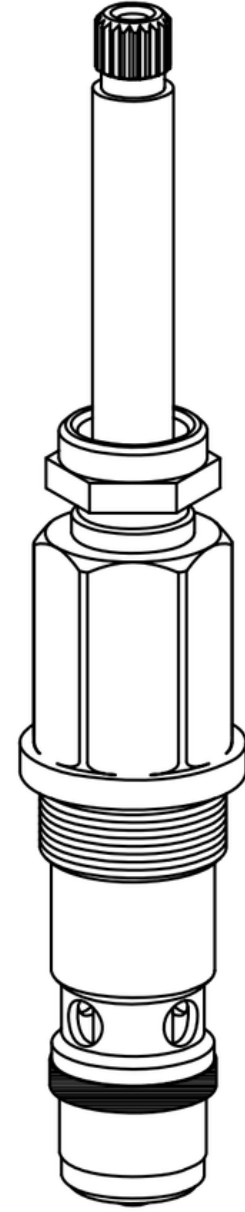

BRIGGS 6-1/8"
DIVERTER
WITH C.P (1)

W60259



18 PT.

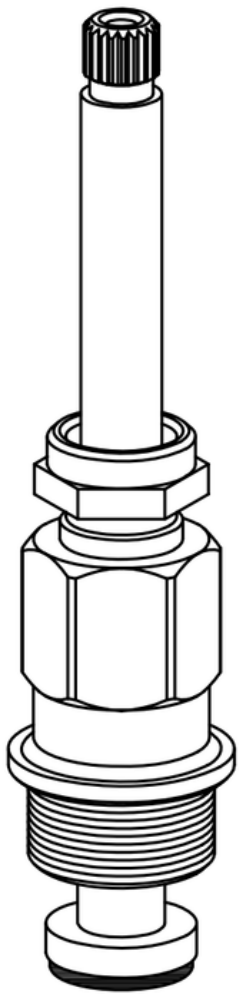

BRIGGS 5"
HOT/COLD

W60261



18 PT.

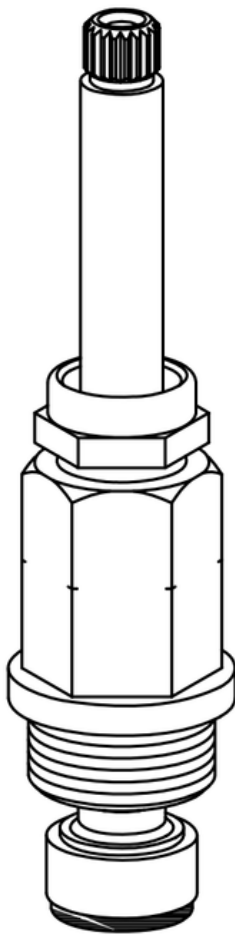

BRIGGS 4-5/8"
COLD
WITH C.P (1)

W60321



16 PT.

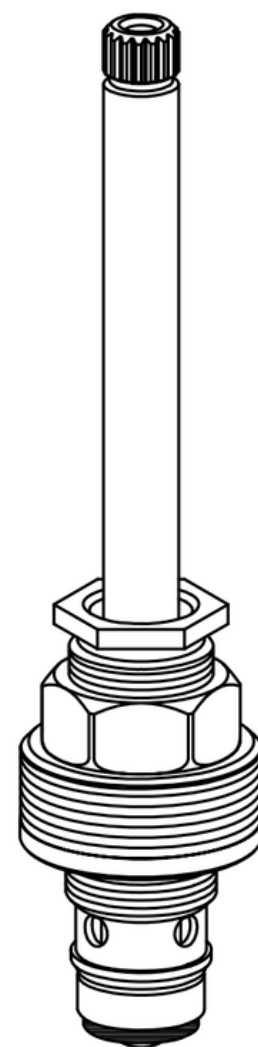

CENTRAL BRASS 5"
DIVERTER

W60323

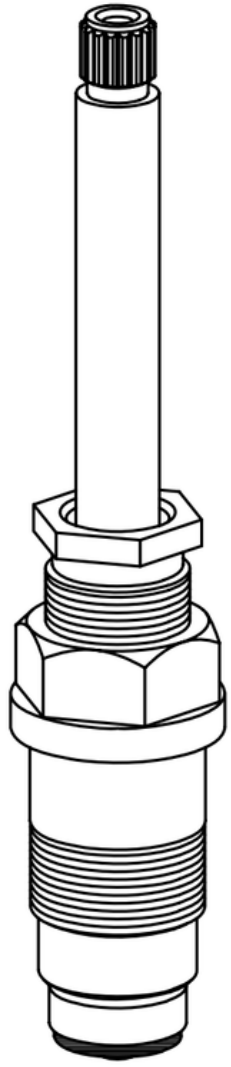

CENTRAL BRASS 5-3/8"
HOT/COLD

W60328

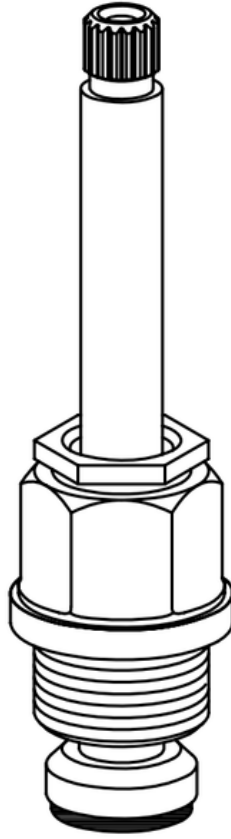

CENTRAL BRASS 4-1/8"
HOT/COLD

W60330

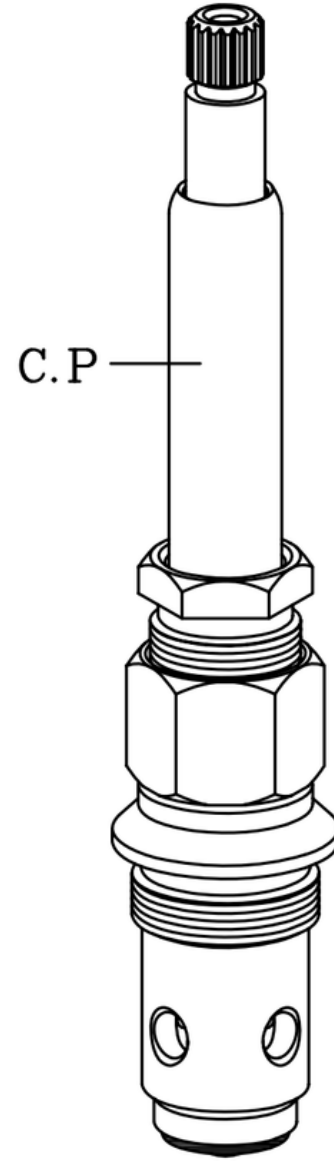

CENTRAL BRASS 5-7/8"
DIVERTER

W60324

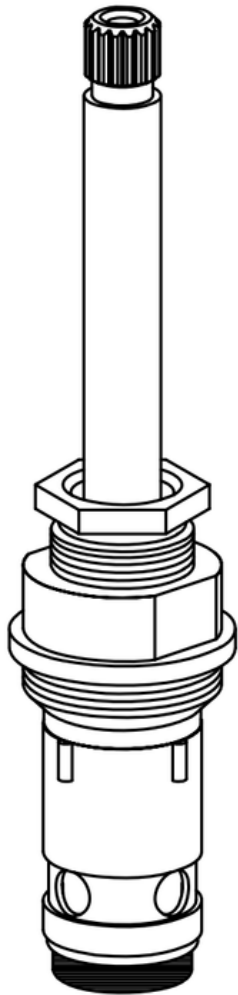

CENTRAL BRASS 5"
DIVERTER

W60329

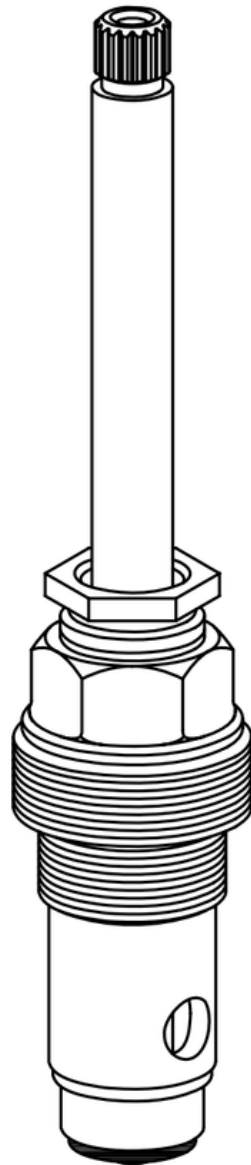

CENTRAL BRASS 5-7/8"
DIVERTER

W60331

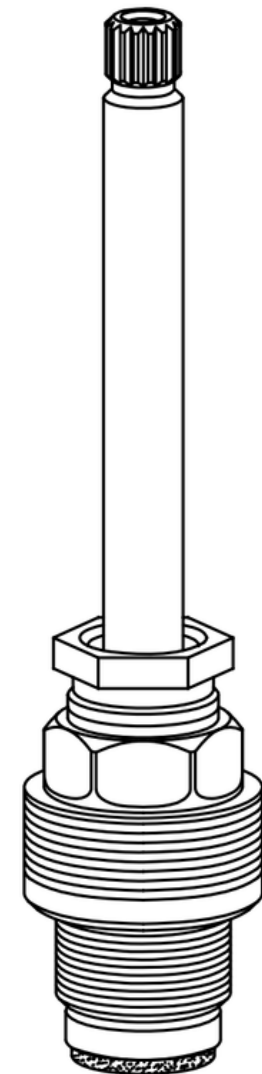

CENTRAL BRASS 5-1/2"
HOT/COLD

W60332



16 PT.

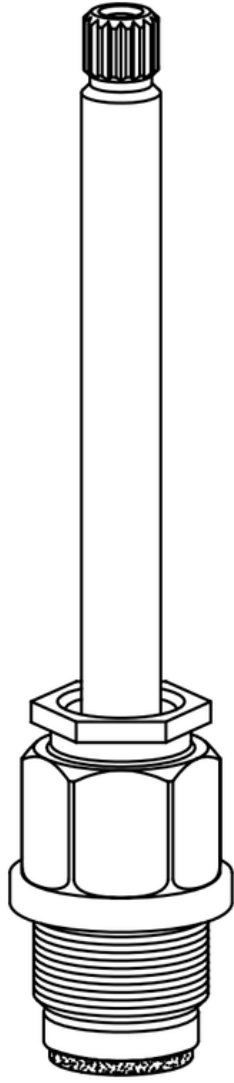

CENTRAL BRASS 5-1/2"
HOT/COLD

W60334



12 PT.

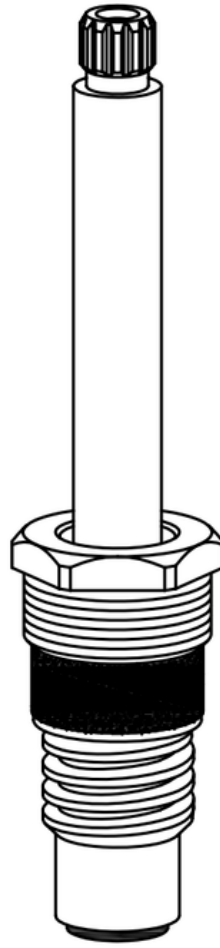

CRANE 4-3/4"
HOT

W60336



16 PT.

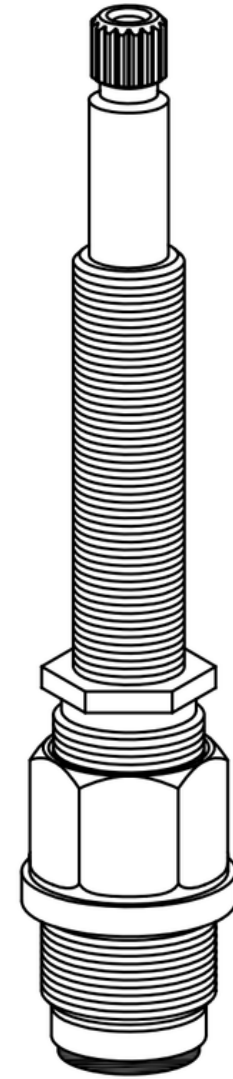

CENTRAL BRASS 5-1/2"
HOT/COLD

W60333



16 PT.

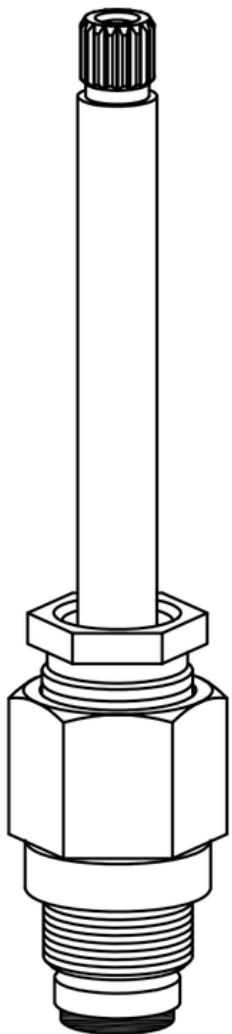

CENTRAL BRASS 5"
HOT/COLD

W60335



12 PT.

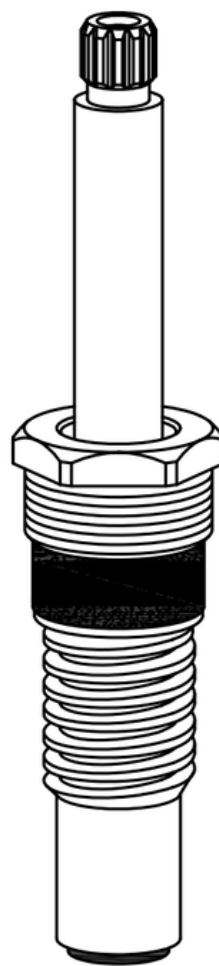

CRANE 4-27/32"
HOT/COLD

W60337



16 PT.

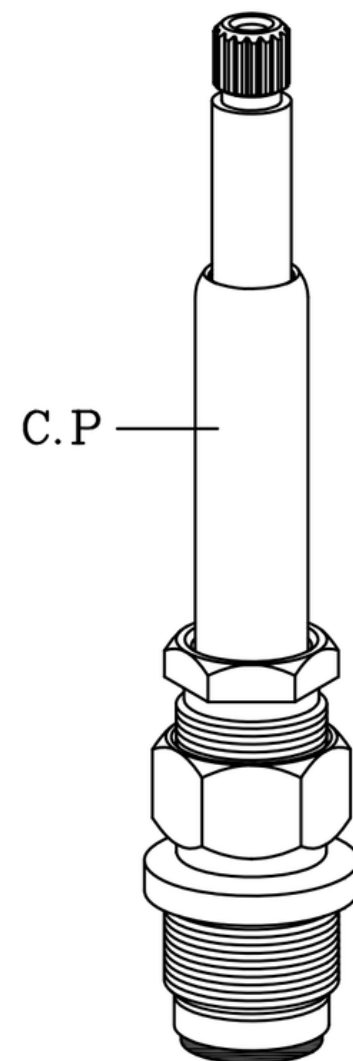

CENTRAL BRASS 5-1/2"
HOT/COLD
WITH C.P (1)

W60338

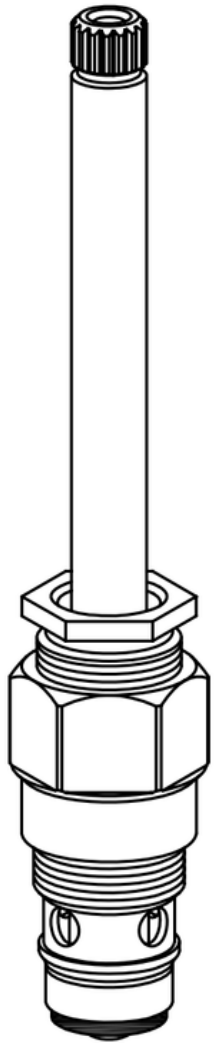

CENTRAL BRASS 5"
DIVERTER

W60341

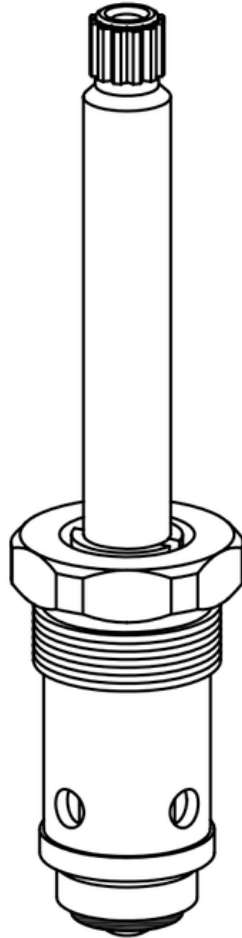

CRANE 4-3/4"
DIVERTER

W60340

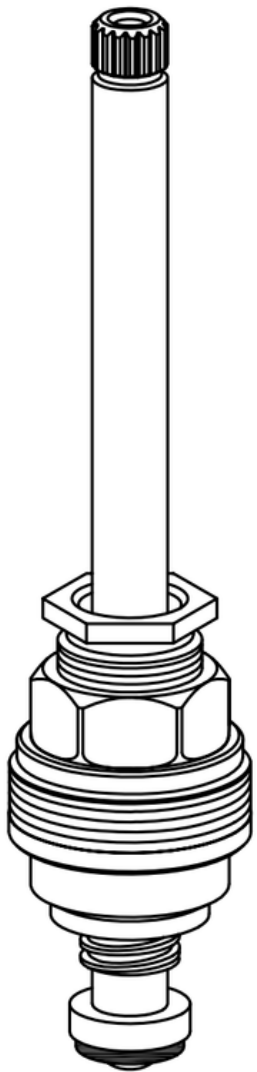

CENTRAL BRASS 5-13/32"
HOT/COLD

W60344

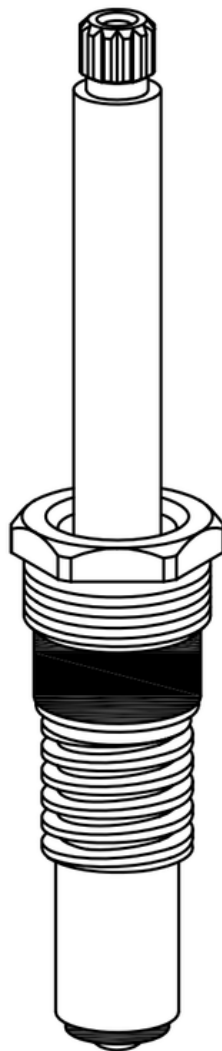

CRANE 5-3/8"
HOT/COLD
WITH C.P (1)

W60346

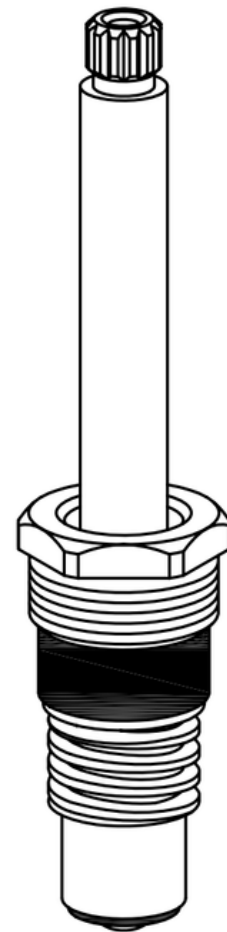

CRANE 4-3/4"
COLD

W60349



12 PT.

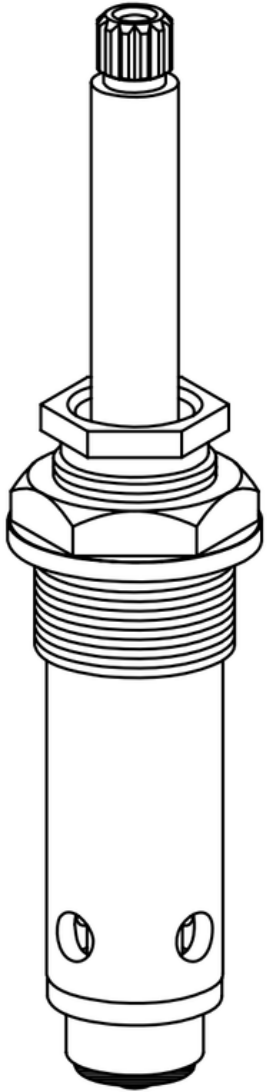

CRANE 5-1/2"
DIVERTER

W60520



16 PT.

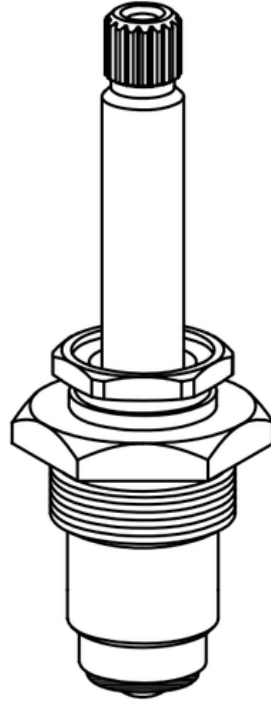

ELJER 3-1/2"
HOT
WITH C.P (1)

W60524



16 PT.

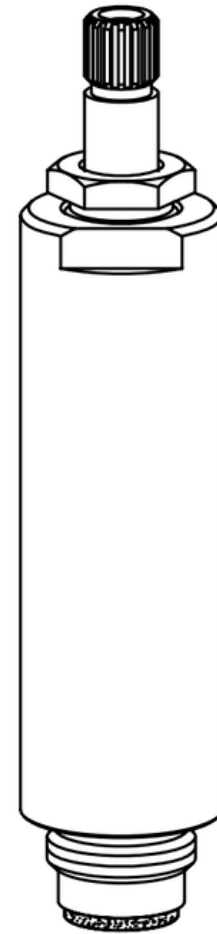

ELJER 4-21/32"
HOT/COLD
WITH C.P (2)

W60383



16 PT.

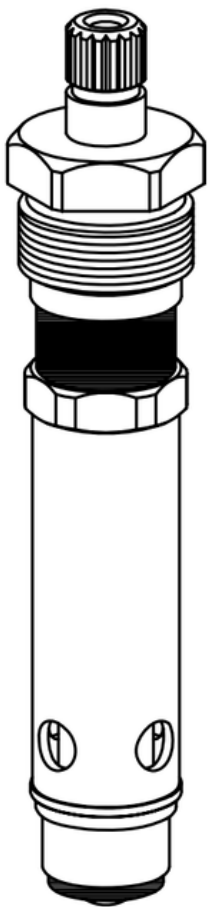

CUTHBERT & BELANGER
4-9/16"
DIVERTER

W60521



16 PT.

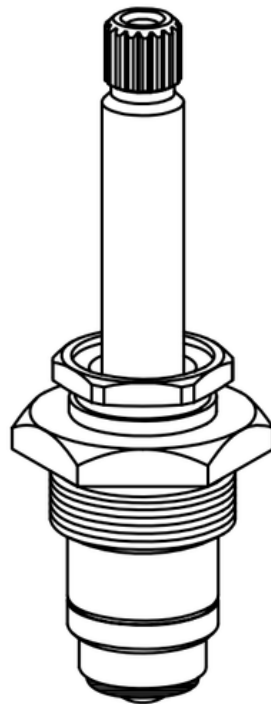

ELJER 3-1/2"
COLD
WITH C.P (1)

W60525



16 PT.

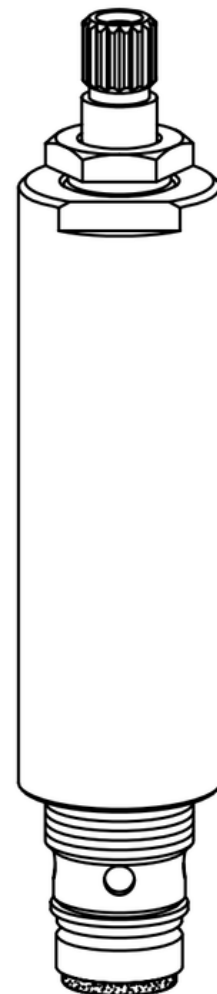

ELJER 5-1/16"
DIVERTER
WITH C.P (2)

W60526

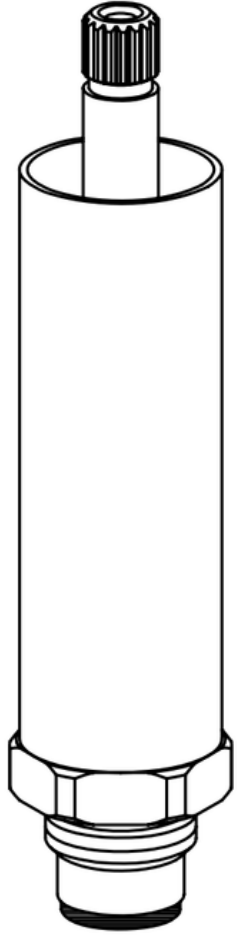

ELJER 4-21/32"
HOT/COLD
WITH C.P (SLEEVE)

W60528

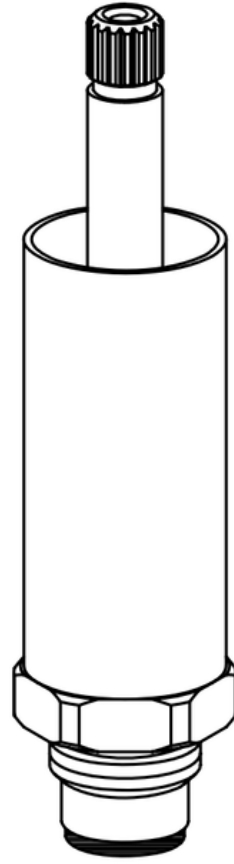

ELJER 4-11/32"
HOT/COLD
WITH C.P(SLEEVE)

W60530A

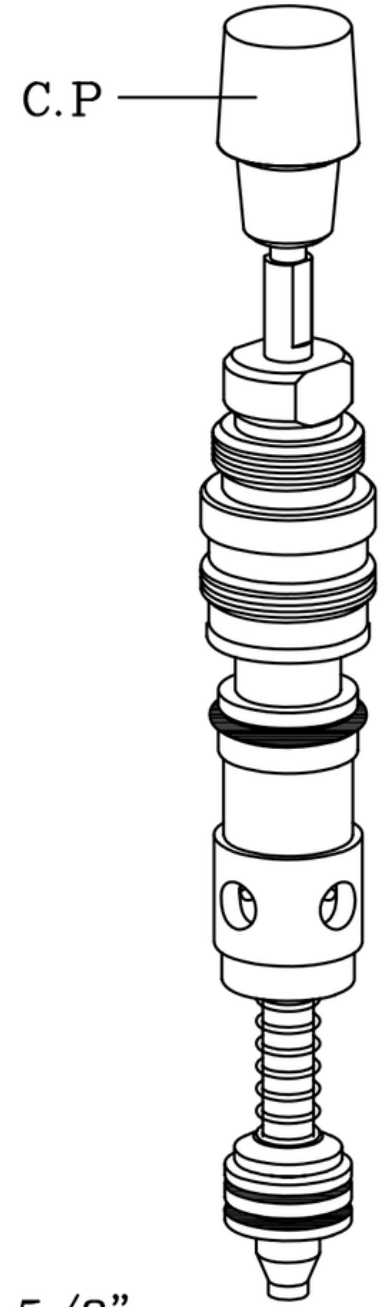

EMCO 6-5/8"
DIVERTER

W60527

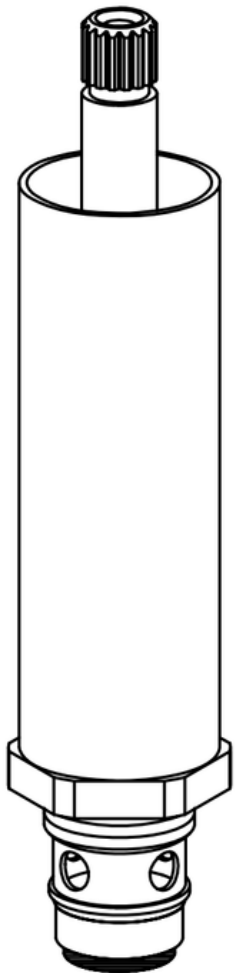

ELJER 5"
DIVERTER
WITH C.P (SLEEVE)

W60529

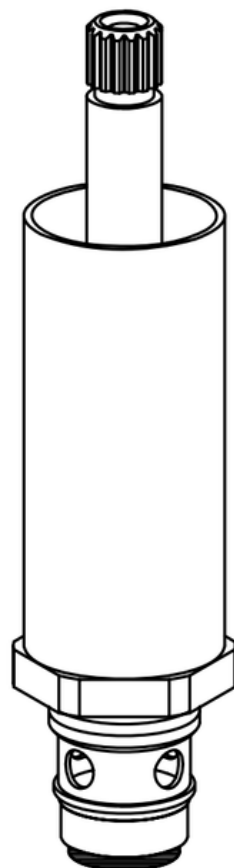

ELJER 4-11/16"
DIVERTER
WITH C.P(SLEEVE)

W60531

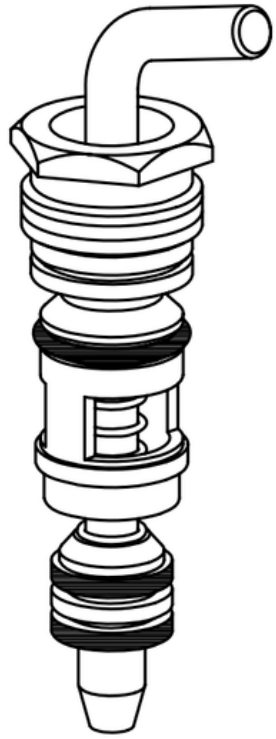

EMCO 3"
DIVERTER

W60533



16 PT.

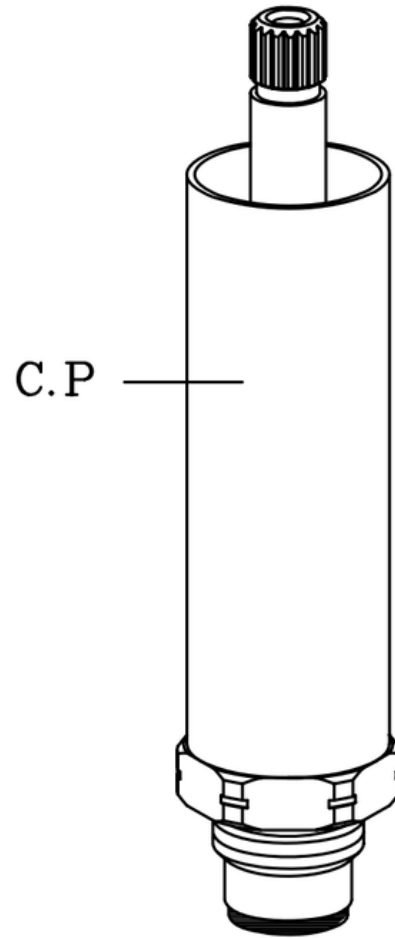

ELJER 4-21/32"
COLD
WITH C.P

W60564



16 PT.

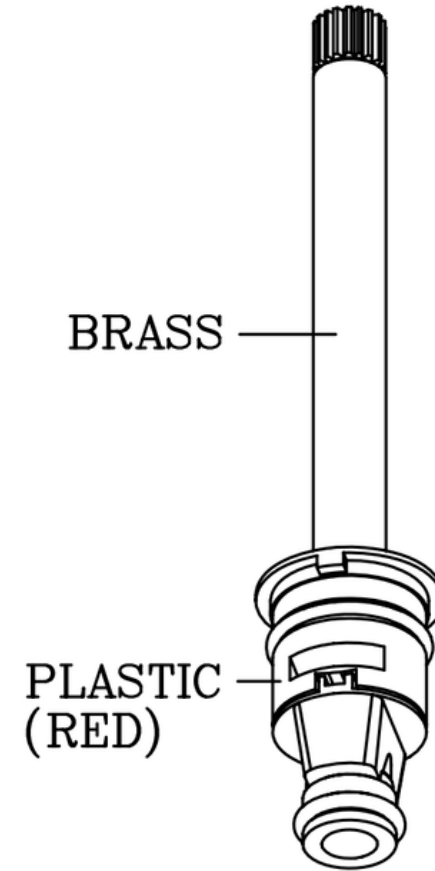

ELKAY
HOT

W60532

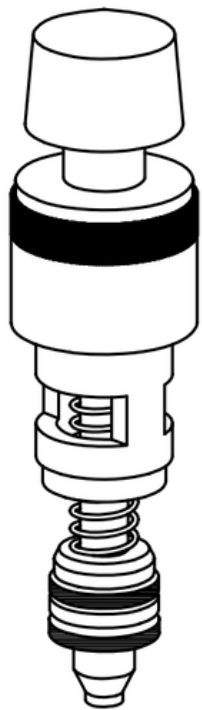

EMCO
DIVERTER
WITH C.P (3,4)

W60551



16 PT.

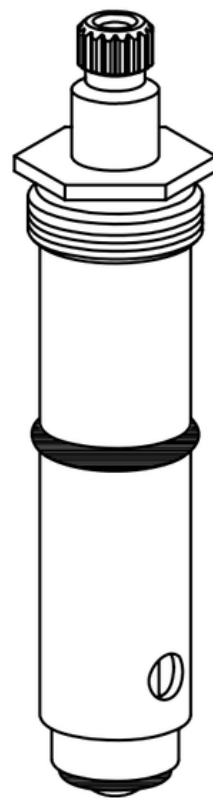

EMCO 4"
DIVERTER

W60565



16 PT.

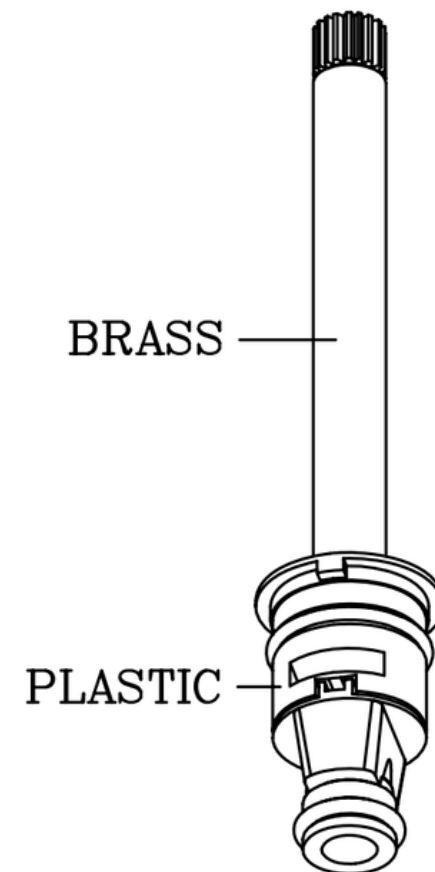

ELKAY
COLD

W60701



20 PT.

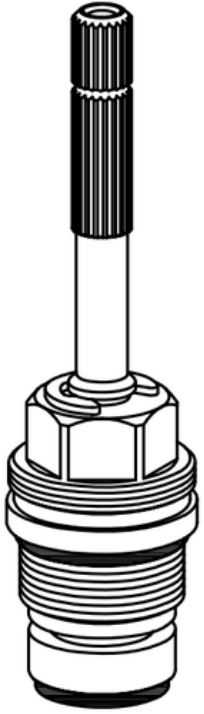

GROHE 3-1/2"
HOT/COLD

W60778



16 PT.

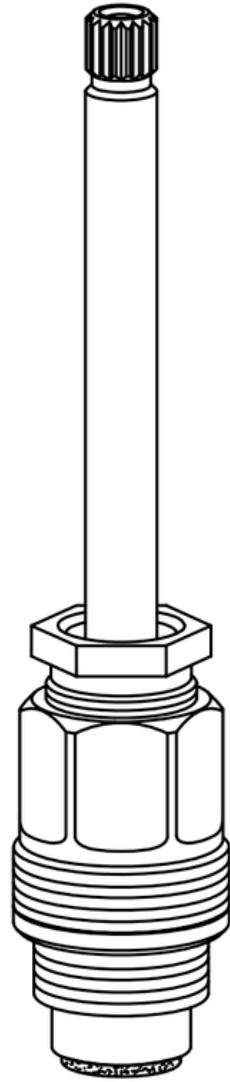

GERBER 5-1/4"
HOT/COLD

W60779



16 PT.

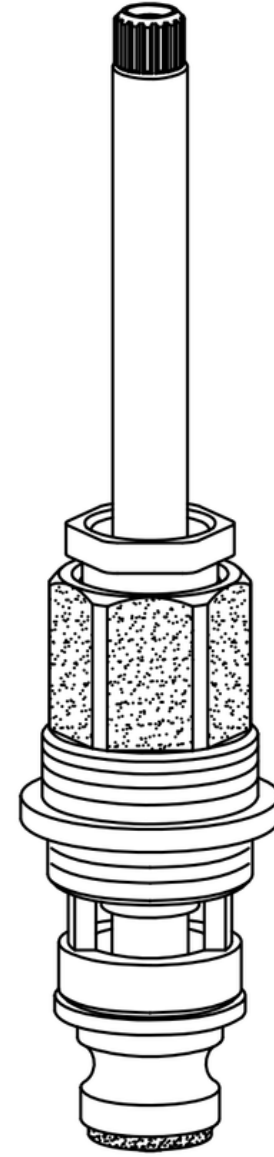

GERBER 5-3/4"
DIVERTER

W60711



16 PT.



GALT
HOT

W60778B



16 PT.

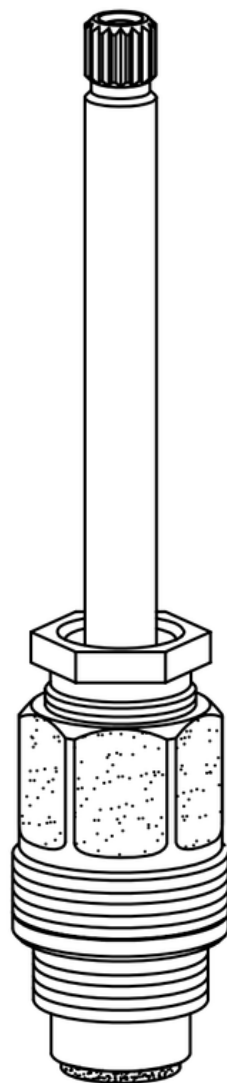

GERBER 5-1/4"
HOT/COLD

W60831



12 PT.

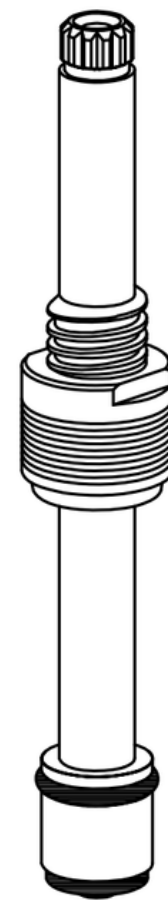

HARCRAFT 4-1/2"
HOT/COLD

W60833

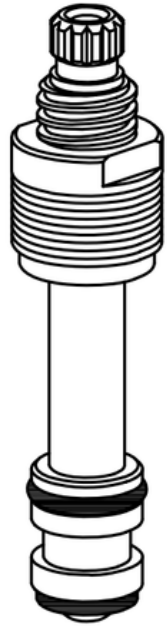

HARCRAFT 3-1/8"
HOT/COLD

W60835

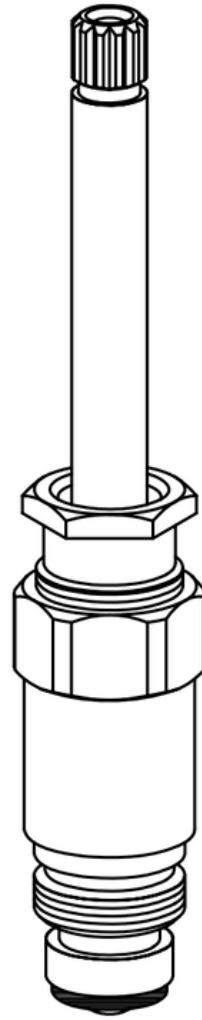

HARCRAFT 5-3/16"
HOT/COLD
WITH C.P (1)

W60912

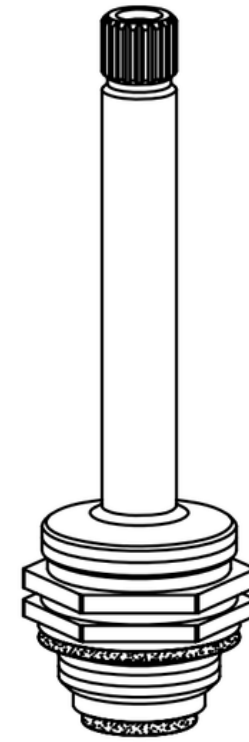

INDIANA 3-21/32"
COLD

W60834

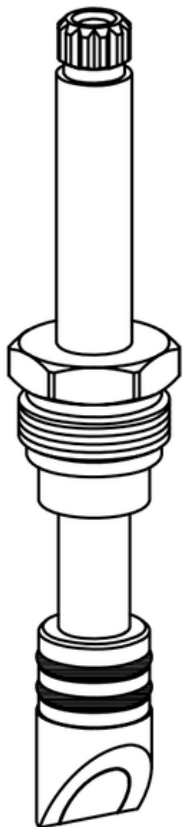

HARCRAFT 4-1/4"
DIVERter

W60911

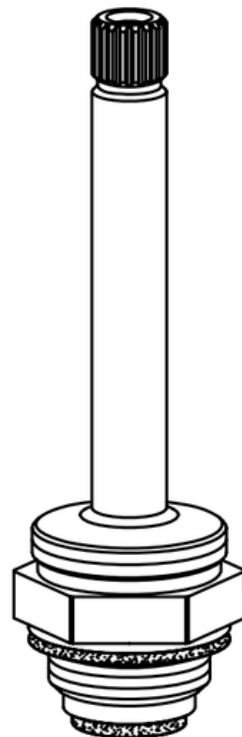

INDIANA 3-21/32"
HOT

W60913

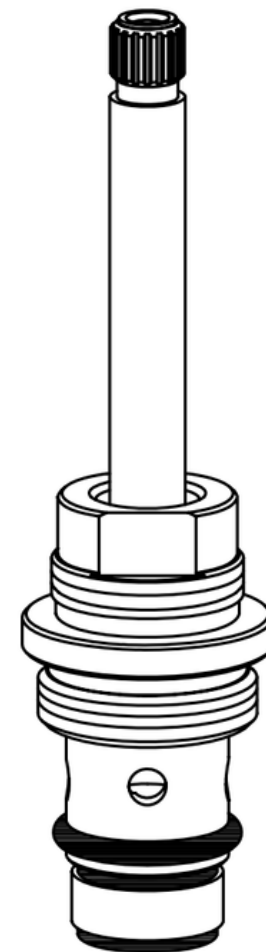

INDIANA 4-3/4"
DIVERter

W60919



18 PT.

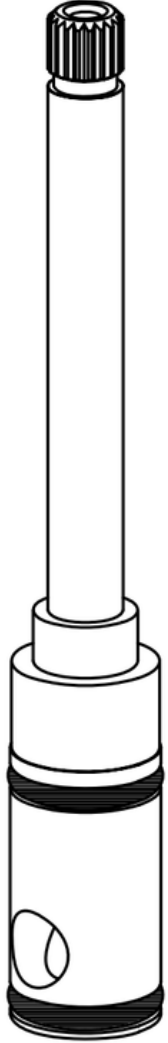

INDIANA BRASS 5-1/4"
DIVERTER

W61101



16 PT.

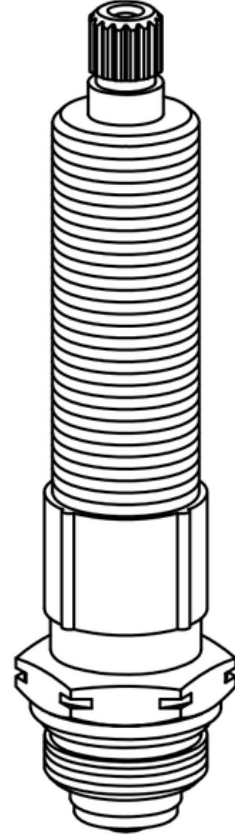

KOHLER 4-1/4"
HOT/COLD

W61103



16 PT.

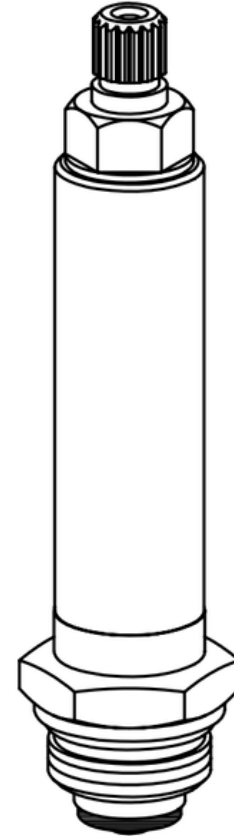

KOHLER 4-1/4"
COLD
WITH C.P (3)

W60920

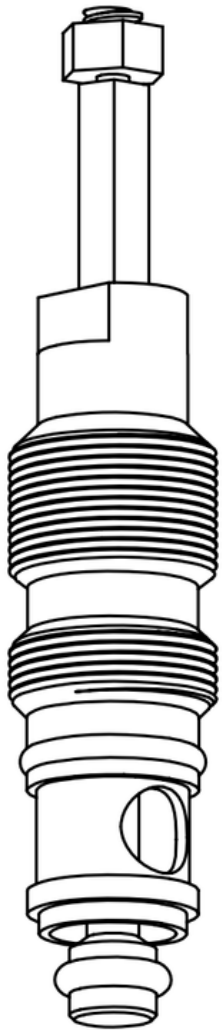

INVERSUER CUTHBERT
HOT

W61102



16 PT.

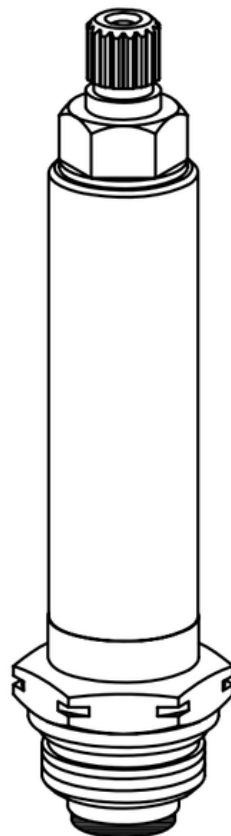

KOHLER 4-1/4"
HOT
WITH C.P (3)

W61104



19 PT.

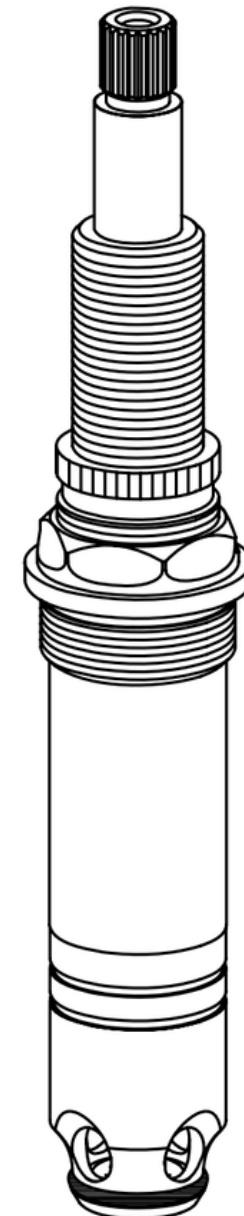

KOHLER 6-1/8"
HOT/COLD
WITH C.P (1)

W61105



19 PT.

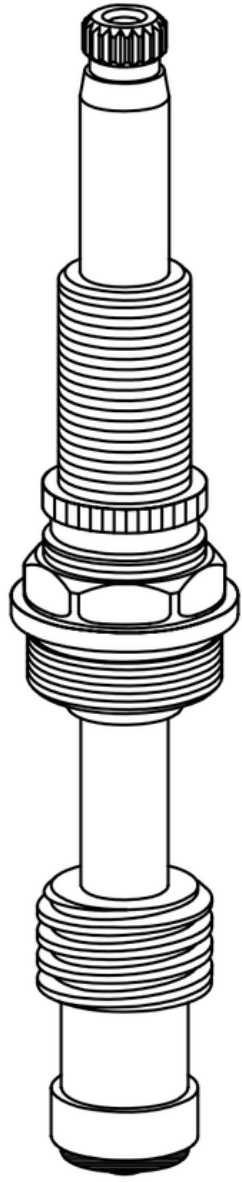

KOHLER 6"
HOT/COLD
WITH C.P (1)

W61112



16 PT.

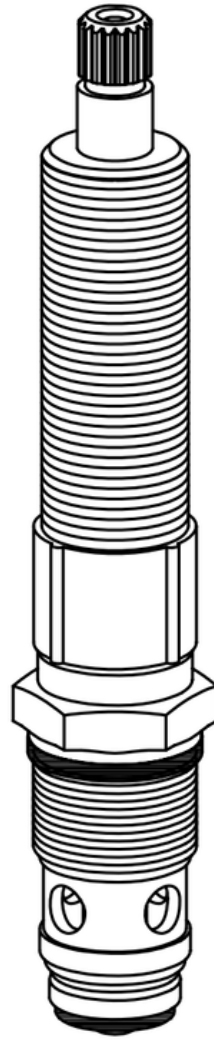

KOHLER 5-1/4"
DIVERTER

W61114

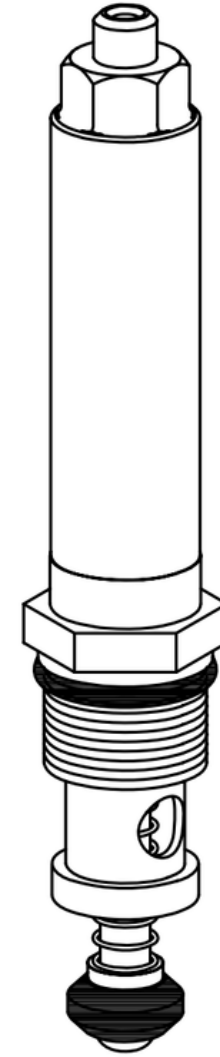

KOHLER 5-13/32"
DIVERTER
WITH C.P (3)

W61111



16 PT.

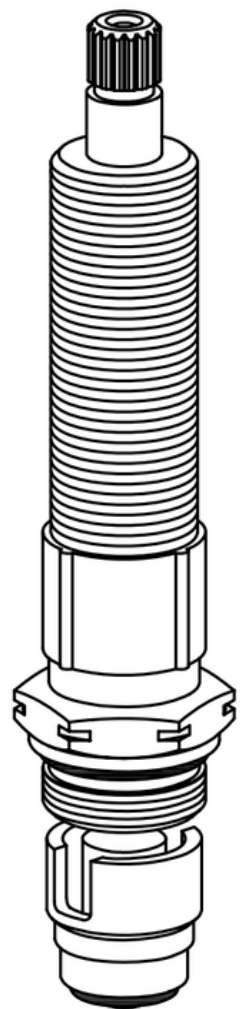

KOHLER 5"
DIVERTER

W61113



19 PT.

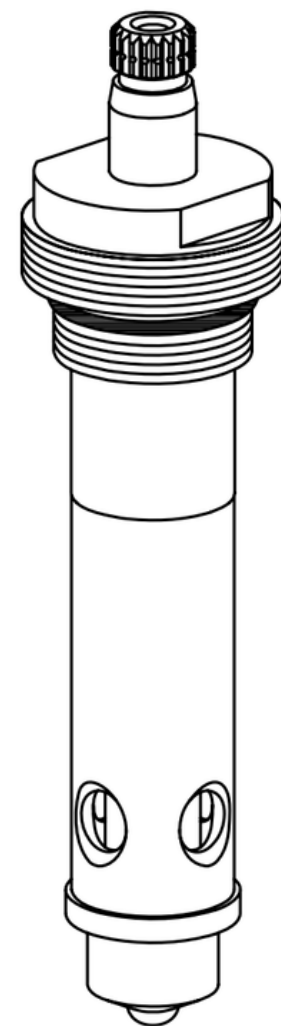

KOHLER 5-1/8"
DIVERTER
WITH C.P (1)(2)

W61115

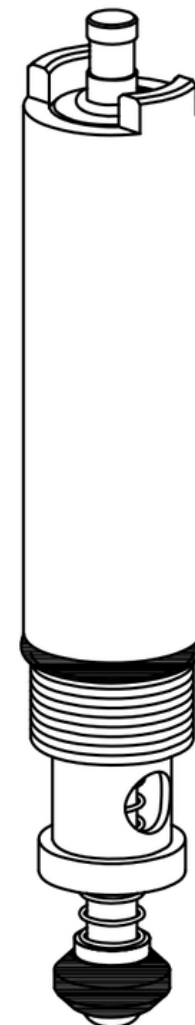

KOHLER 5-1/4"
DIVERTER
WITH C.P (2)

W61117

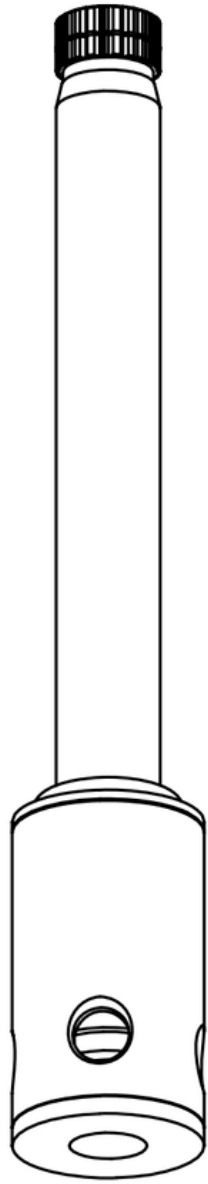

KOHLER 5-1/16"
HOT
WITH C.P (1)

W61302



MUELLER 5-3/8"
DIVERTER

W61301

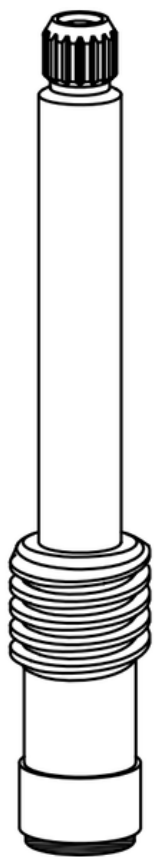

MUELLER 4-5/16"
HOT/COLD

W61303



PLASTIC
BRASS

MOEN 4-1/8"
BRASS STEM

W61305



MOEN BRASS 4-1/8"

W61306



MOEN 4-1/8"
HOT/COLD

W61324



12 PT.

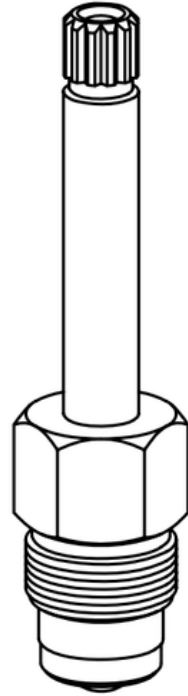

MILWAUKEE 3-1/2"
HOT/COLD

W61323



16 PT.

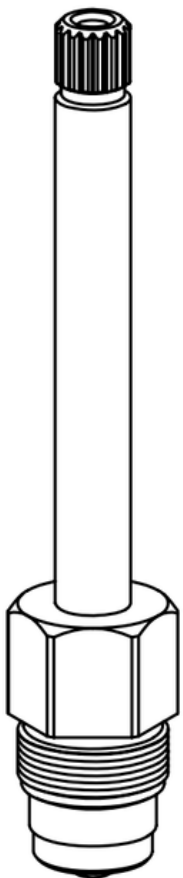

MILWAUKEE 4-15/32"
HOT/COLD

W61341



12 PT.

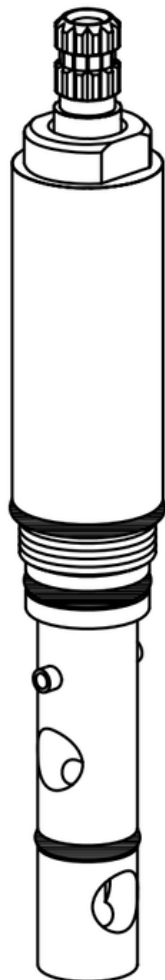

MICHGAN BRASS 4-29/32"
DIVERTER
WITH C.P (2)

W61348



MIXET 4-1/2"
HOT/COLD
WITH C.P(4)

W61351

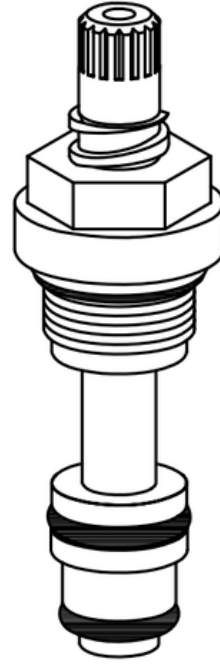

PLASTIC

MIDCOR 4-11/32"
HOT/COLD

W61349

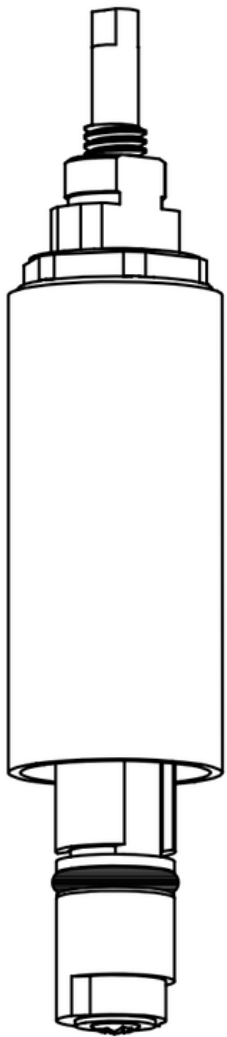

MIXET 6"
HOT/COLD
WITH C.P(4)

W61611

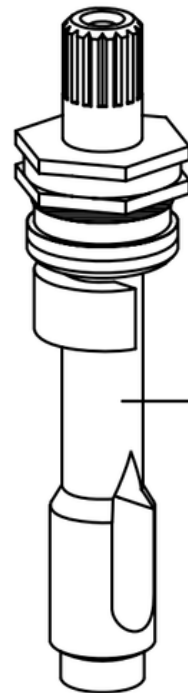

PLASTIC

PHOENIX 3-1/2"
DIVERter

W61625



PRICE PFISTER 5-1/4"
HOT
WITH C.P (1)

W61627

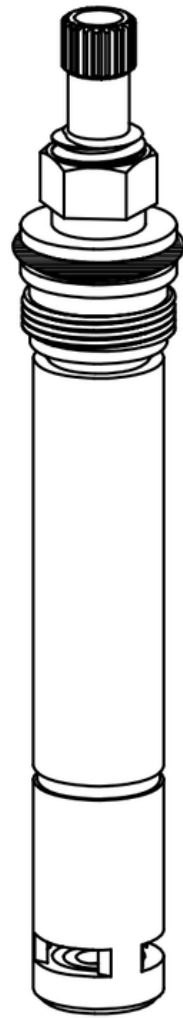

PRICE PFISTER 4-5/8"
HOT

W61643

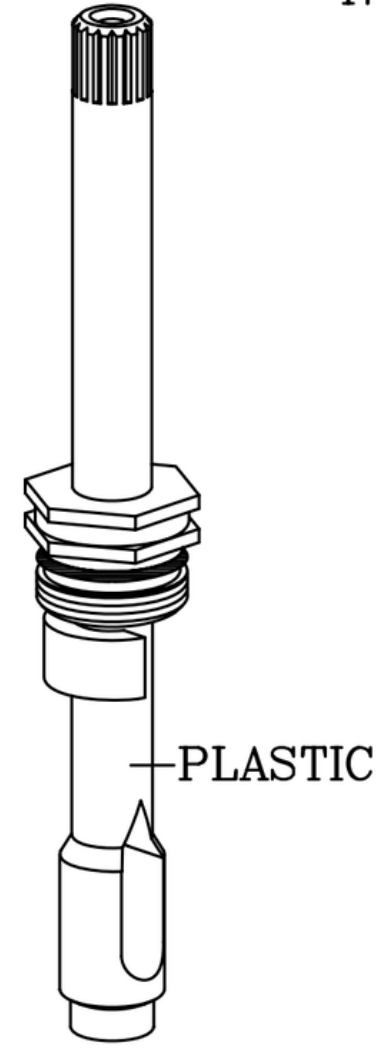

PHOENIX 5-5/16"
DIVERTER

W61626



PRICE PFISTER 5-1/4"
COLD
WITH C.P (1)

W61628

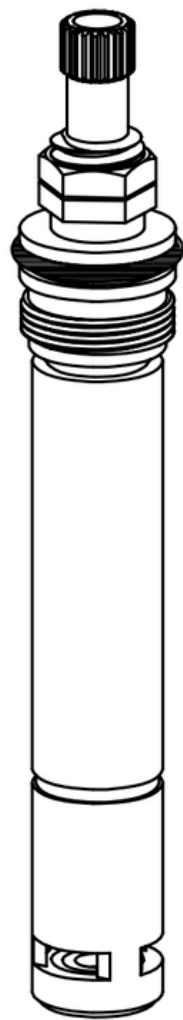

PRICE PFISTER 4-5/8"
COLD

W61650

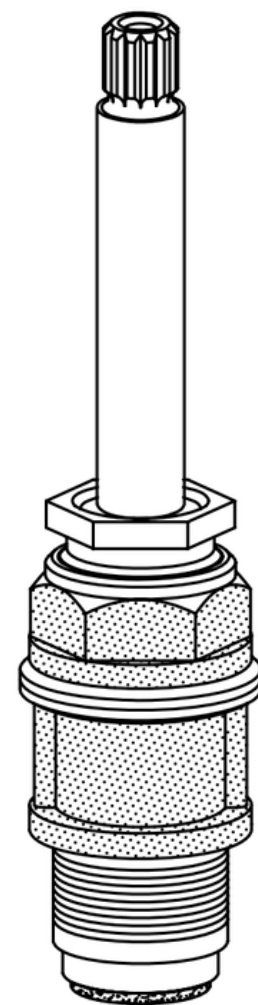

PRICE PFISTER 5"
HOT/COLD
WITH C.P (1)

W61651



12 PT.

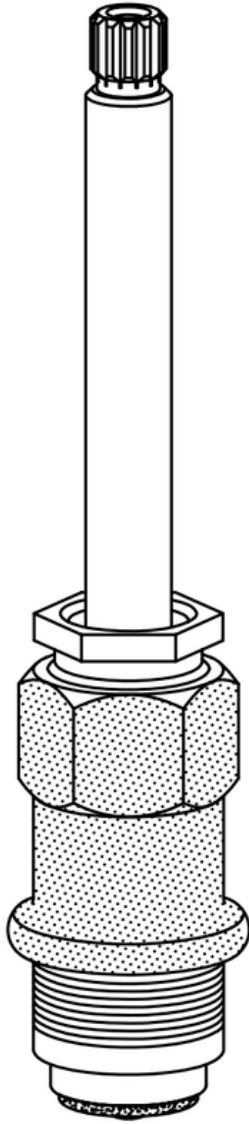

PRICE PFISTER 5-1/2"
HOT/COLD

W61653



12 PT.

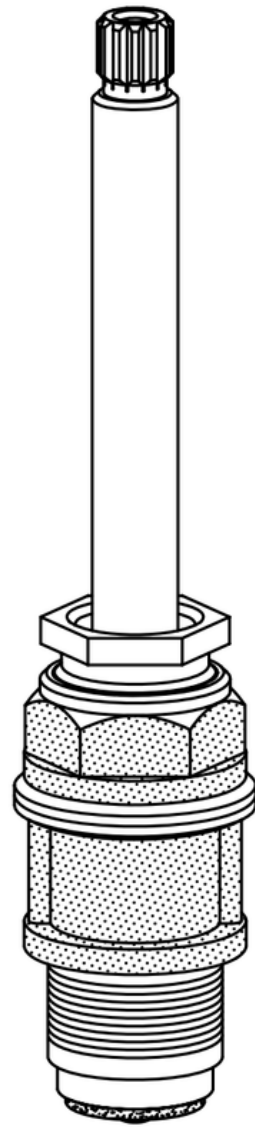

PRICE PFISTER 5-1/2"
HOT/COLD

W61655



12 PT.

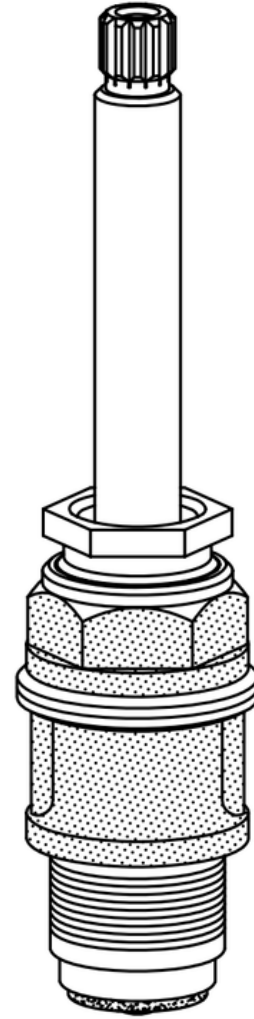

PRICE PFISTER 4-1/4"
HOT/COLD

W61652



12 PT.

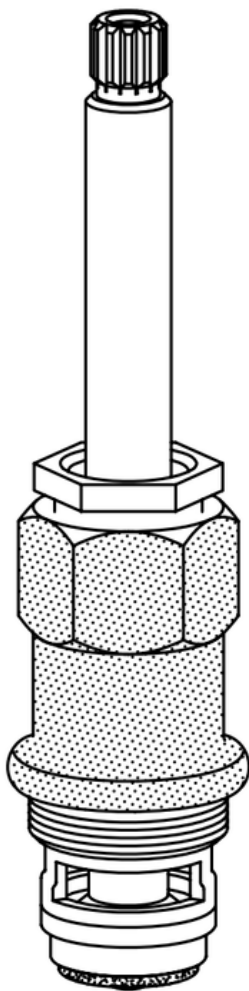

PRICE PFISTER 5-1/2"
DIVERTER

W61654



12 PT.

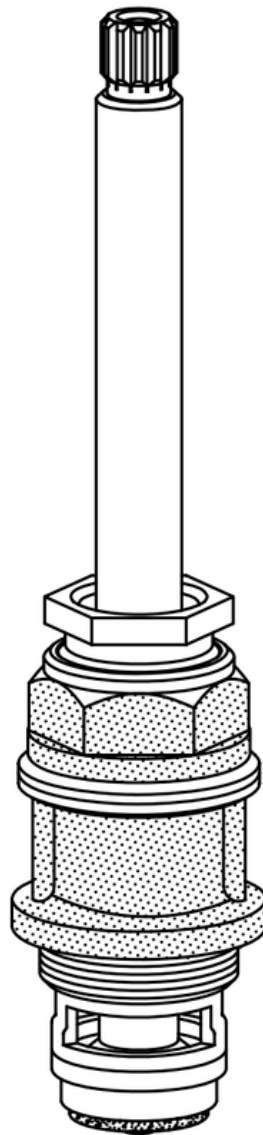

PRICE PFISTER 5-1/2"
DIVERTER

W61656



12 PT.

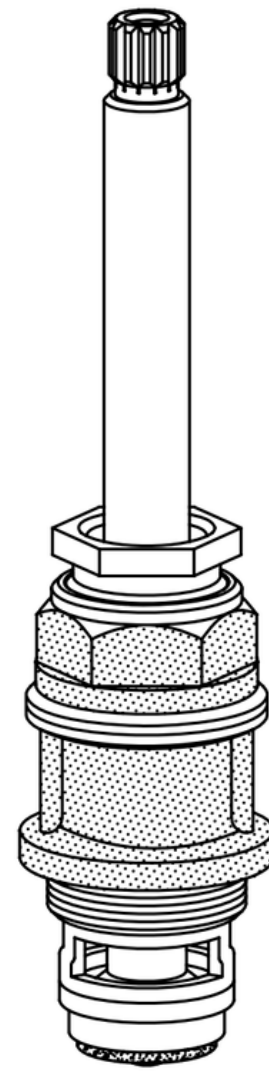

PRICE PFISTER 4-1/4"
DIVERTER

W61657

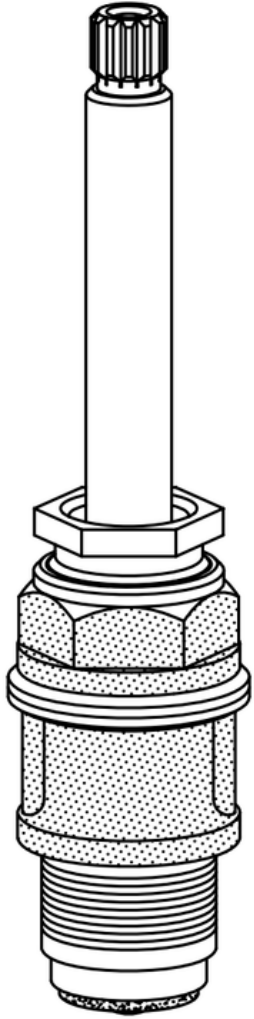

PRICE PFISTER 4-1/4"
COLD

W61659

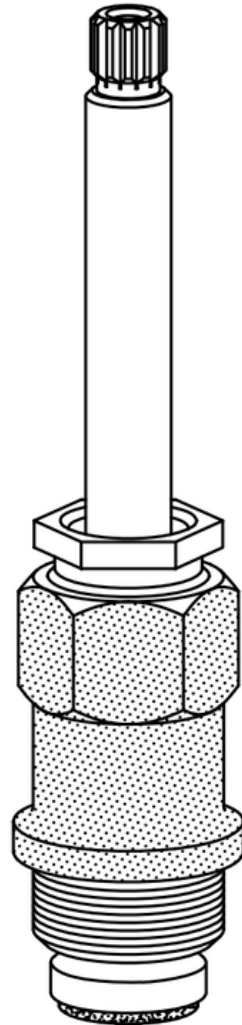

PRICE PFISTER 5"
HOT/COLD
WITH C.P (1)

W61661

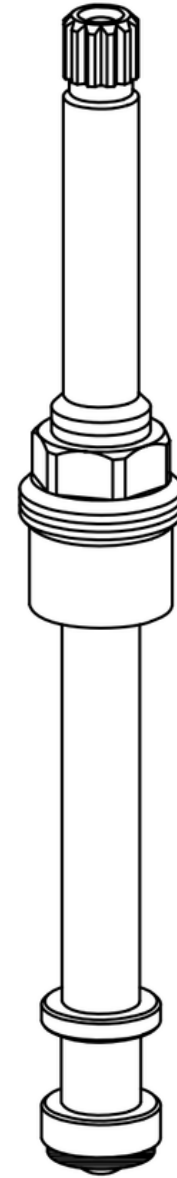

PRICE PFISTER 6"
HOT/COLD

W61658

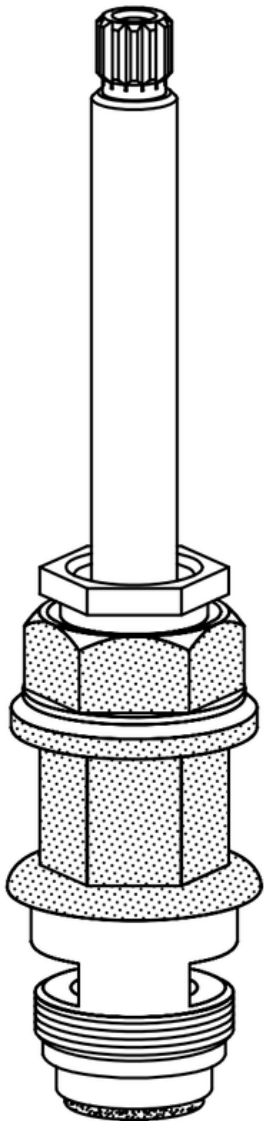

PRICE PFISTER 5"
DIVERTER
WITH C.P (1)

W61660

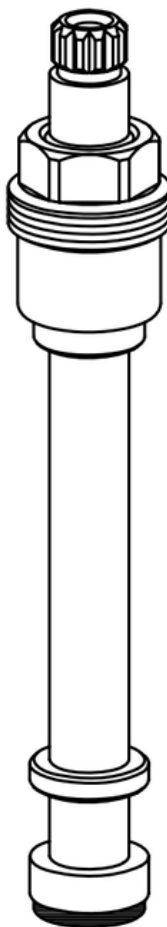

PRICE PFISTER 4-5/8"

W61662

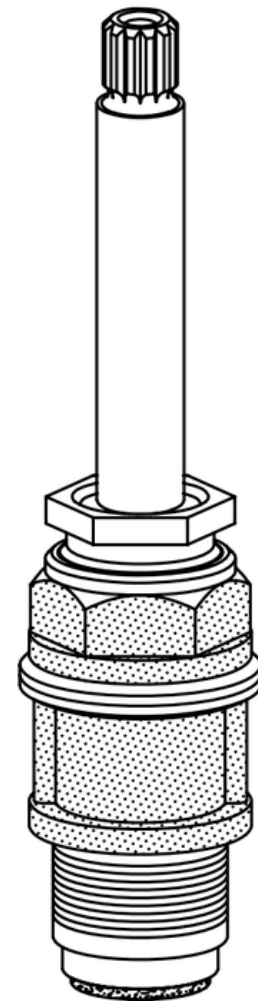

PRICE PFISTER 5"
HOT/COLD
WITH C.P (1)

W61665

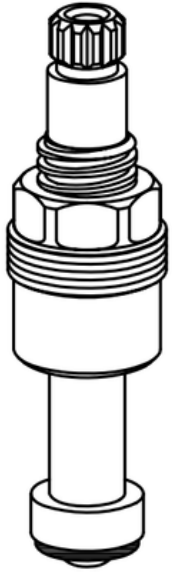

PRICE PFISTER 2-13/16"
HOT

W61667

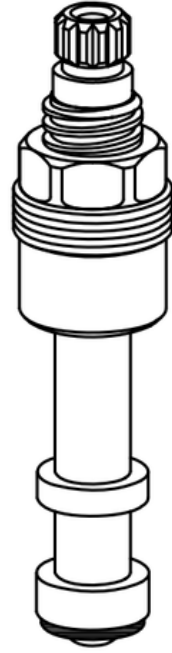

PRICE PFISTER 3-1/4"
HOT

W61801

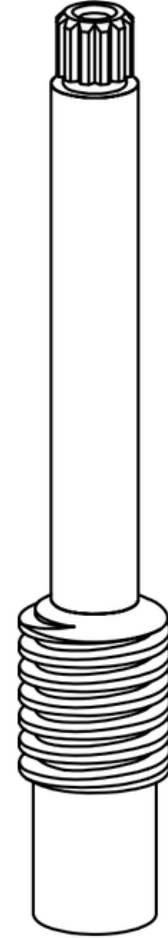

REPCAL 4-27/32"
HOT/COLD

W61666

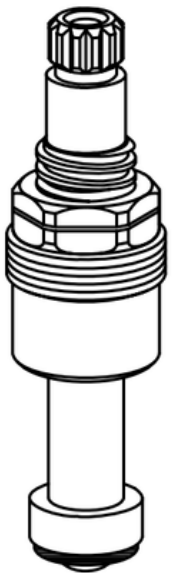

PRICE PFISTER 2-13/16"
COLD

W61668

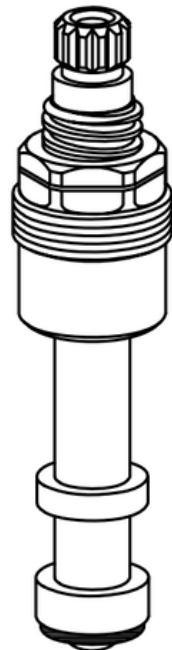

PRICE PFISTER 3-1/4"
COLD

W61802

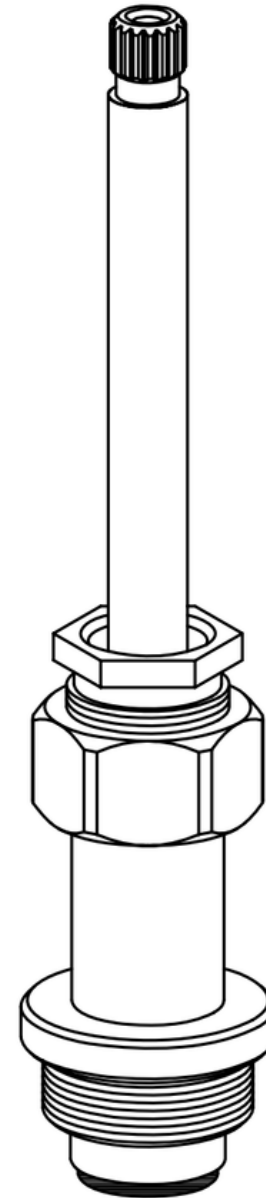

ROYAL BRASS 6-1/8"
HOT/COLD

W61910

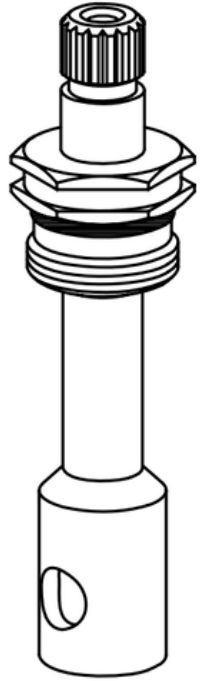

STREAMWAY 3-1/16"
DIVERTER
WITH C.P (2)

W61913

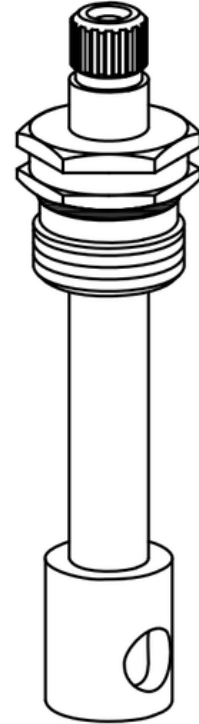

STREAMWAY 3-1/2"
DIVERTER
WITH C.P (2)

W61915

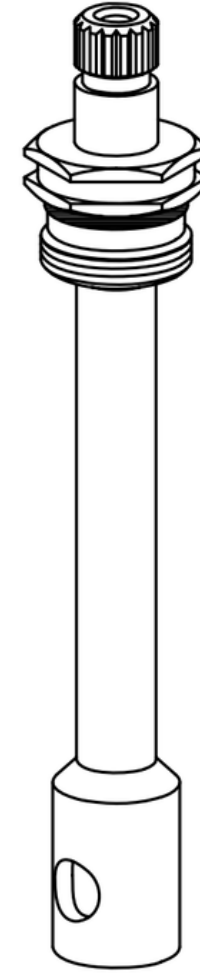

STREAMWAY 4-7/8"
HOT/COLD

W61911

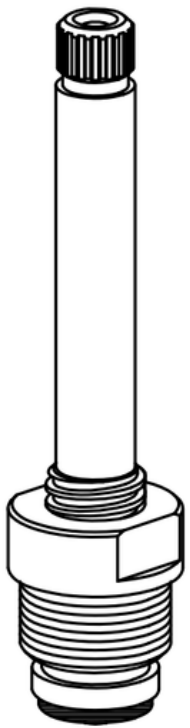

STREAMWAY 3-5/8"
HOT/COLD

W61914

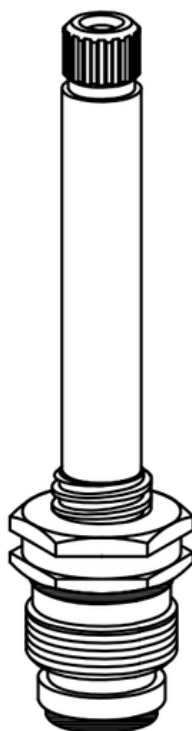

STREAMWAY 3-5/8"
HOT/COLD

W61916

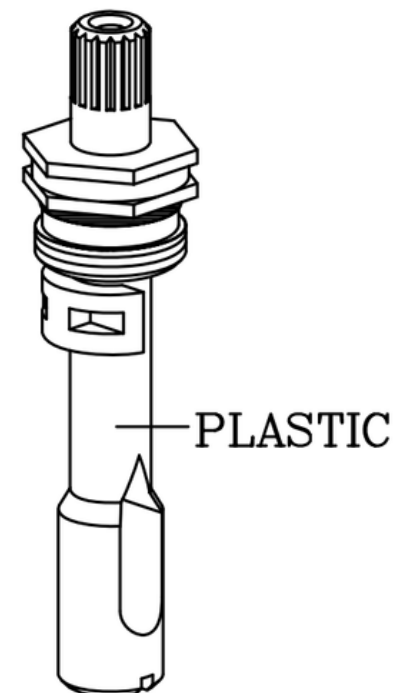

STREAMWAY 3-1/2"
DIVERTER

W61941

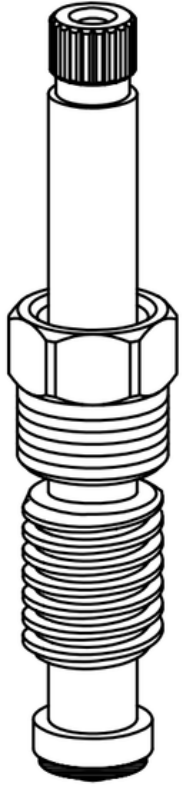

SPEAKMAN 3-31/32"
HOT/COLD

W61943

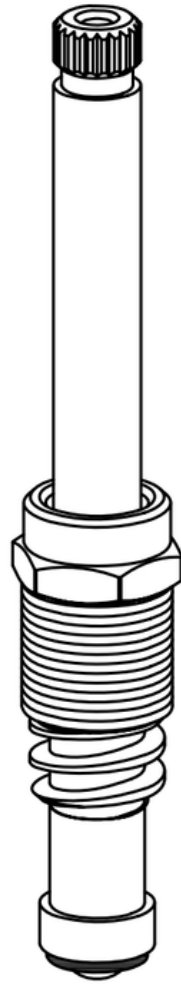

SPEAKMAN 5-1/16"
HOT/COLD
WITH C.P (1)

W61945

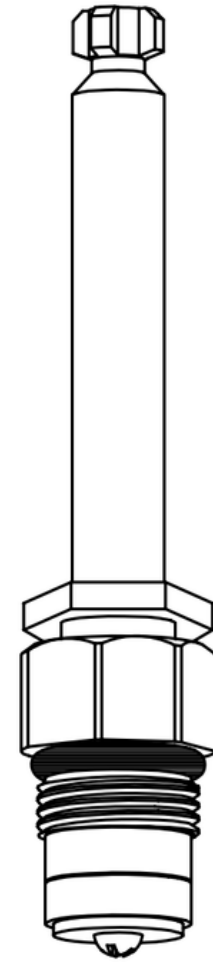

SPEAKMAN
HOT

W61942

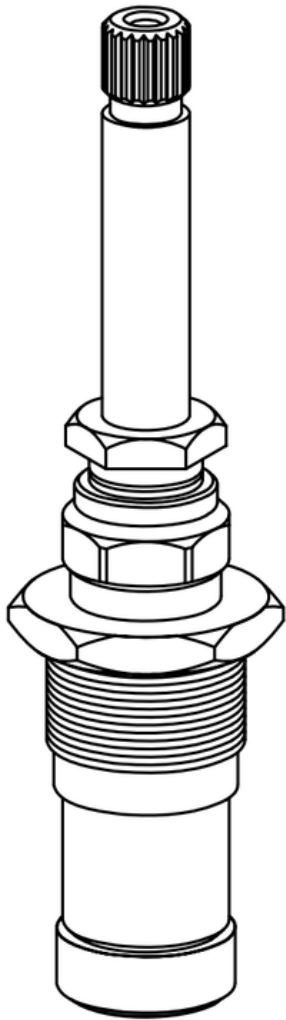

SPEAKMAN 5-1/16"
HOT/COLD
WITH C.P (1)

W61944

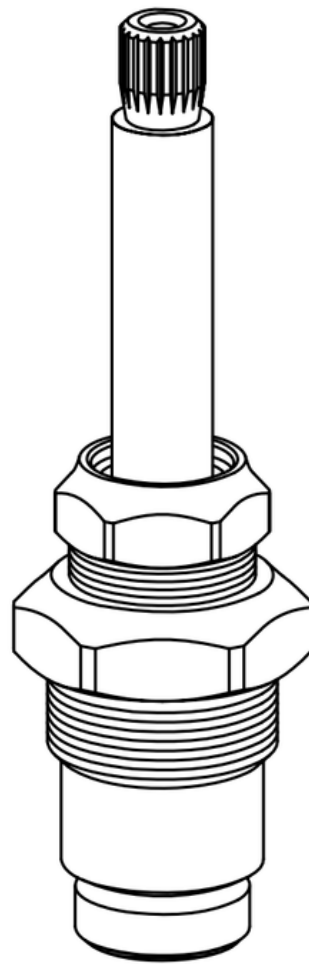

SPEAKMAN 4-3/4"
HOT/COLD
WITH C.P (1)

W61947



SPEAKMAN
HOT/COLD

W61949



16 PT.

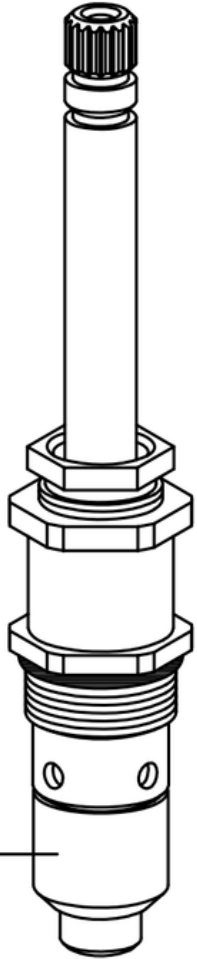

PLASTIC

SAYCO 4-29/32"
DIVERTER

W61951



16 PT.

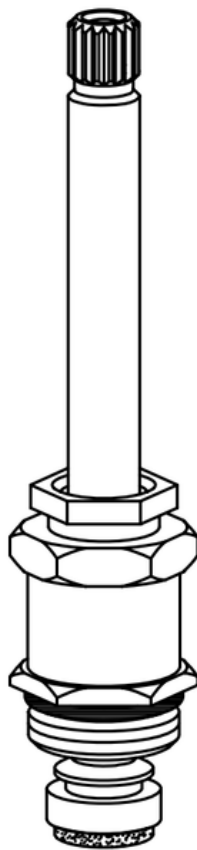

SAYCO 4-1/2"
HOT

W61953



16 PT.

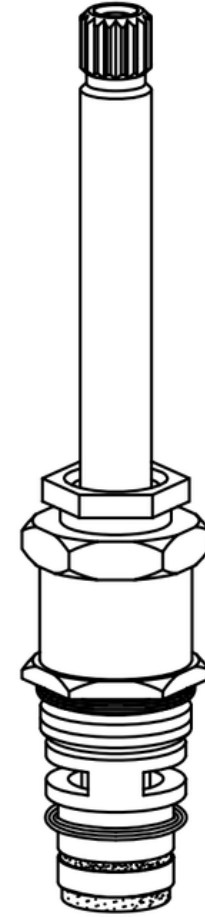

SAYCO 4-1/2"
DIVERTER

W61950



16 PT.

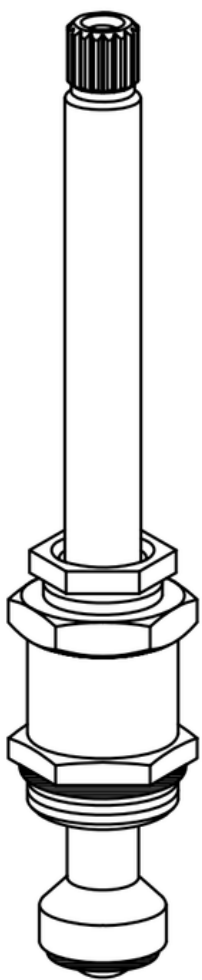

SAYCO 5"
HOT/COLD
WITH C.P (1)

W61952



16 PT.

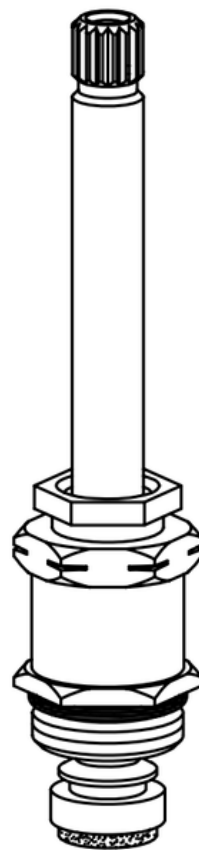

SAYCO 4-1/2"
COLD

W61954



16 PT.

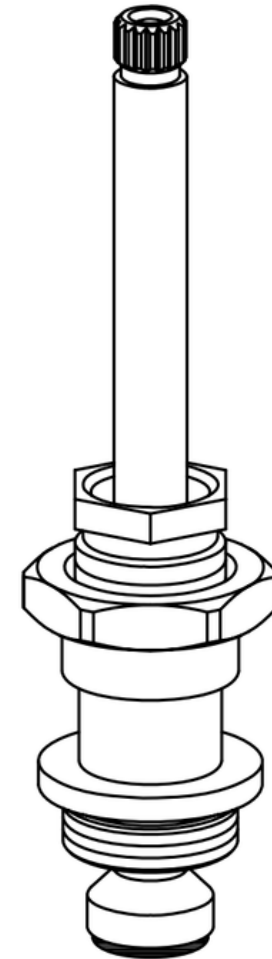

SAYCO 5"
HOT/COLD
WITH C.P (1)

W61957

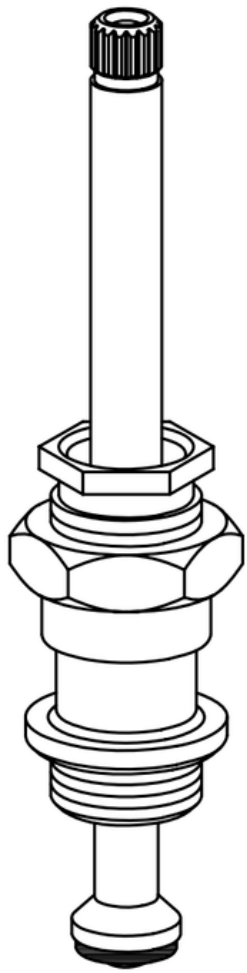

SAYCO 4-15/16"
HOT/COLD

W61961

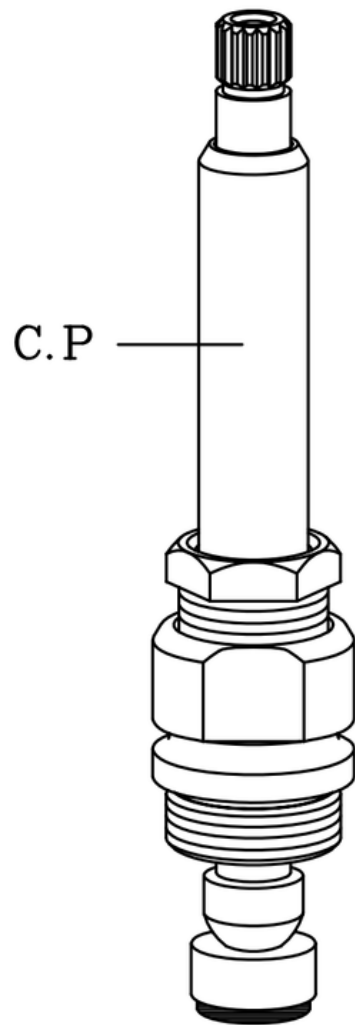

SAVOY 5-1/8"
HOT/COLD
WITH C.P (1)

W61963

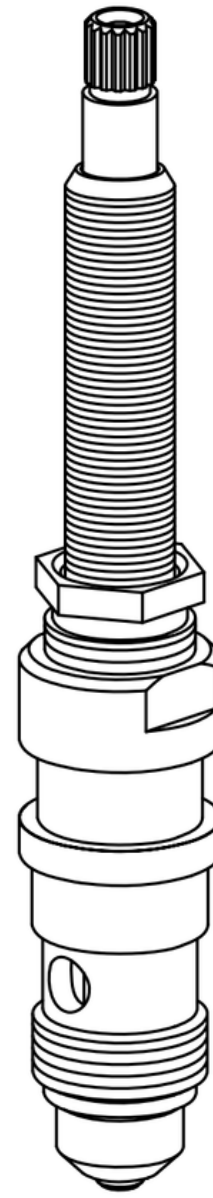

SAVOY 6-1/8"
DIVERTER

W61958

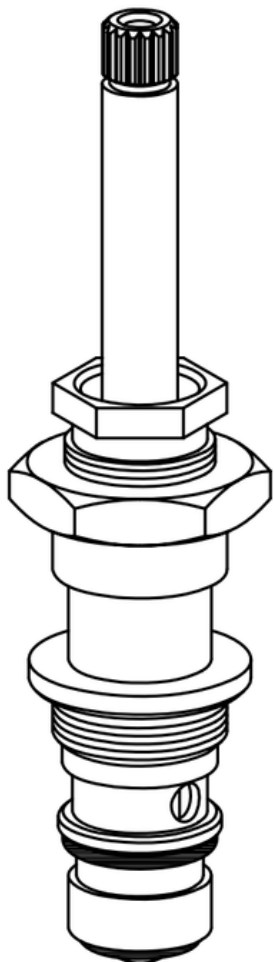

SAYCO 4-13/16"
DIVERTER
WITH C.P (1)

W61962

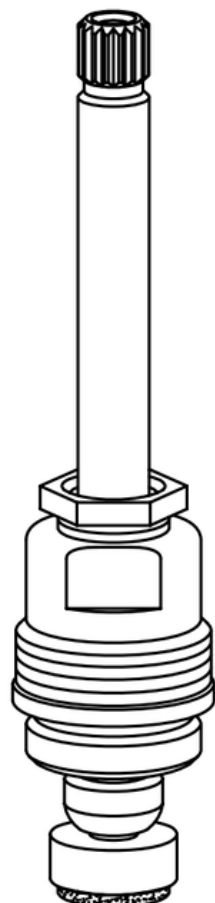

SAVOY 4-19/32"
HOT/COLD

W61963A

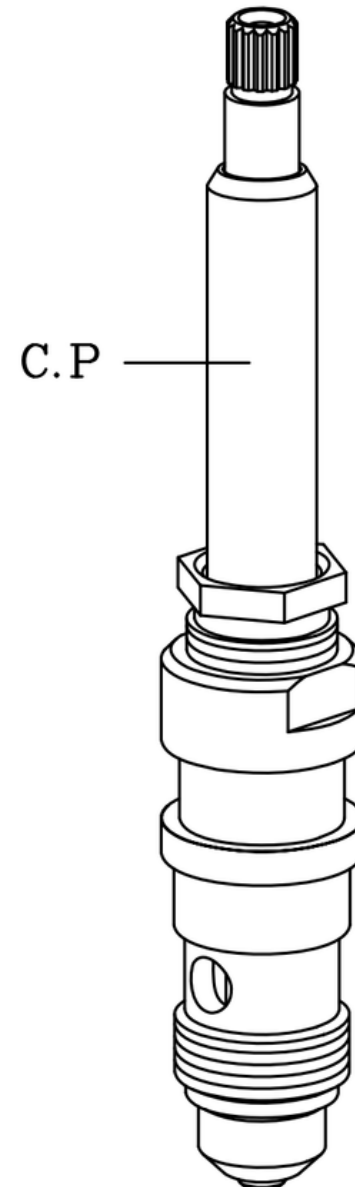

SAVOY 6-1/8"
DIVERTER

W61963X

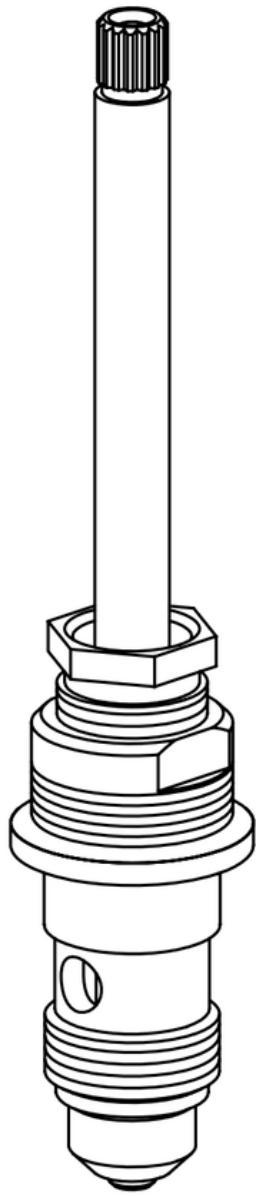

SAVOY 6-1/8"
DIVERTER

W61965



SAVOY 3-5/8"
HOT
WITH C.P (1)

W61967

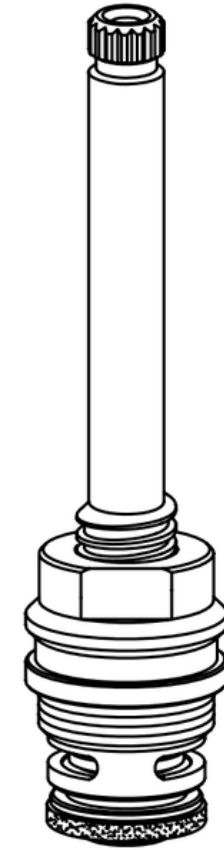

SAVOY 4-1/8'
HOT/COLD

W61964

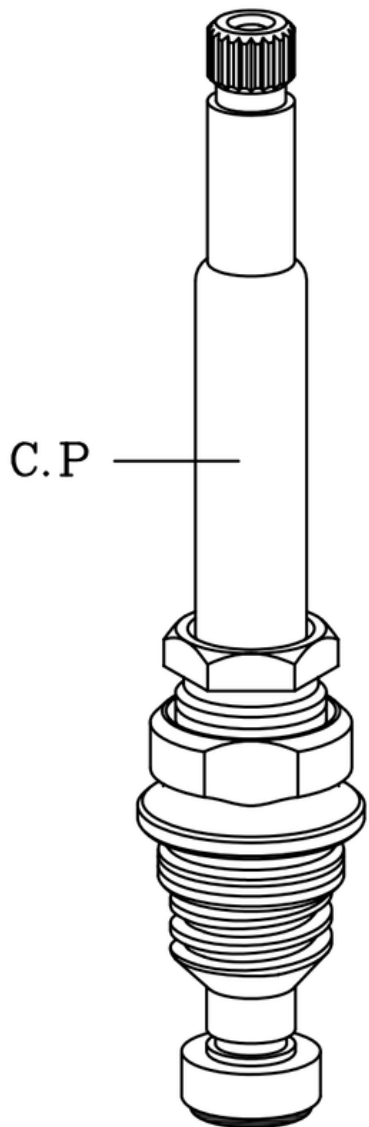

SAVOY 5-3/4"
HOT/COLD
WITH C.P (1)

W61966



SAVOY 3-5/8"
COLD
WITH C.P (1)

W61968

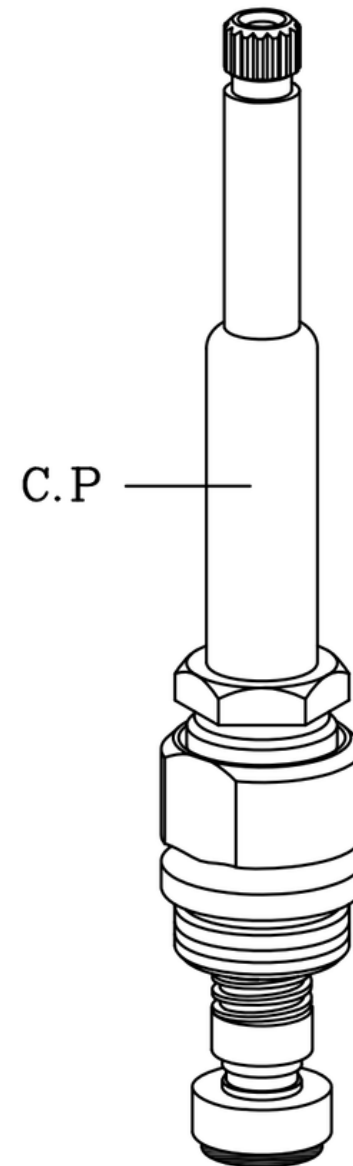

SAVOY 5-13/16"
HOT/COLD
WITH C.P (1)

W61969

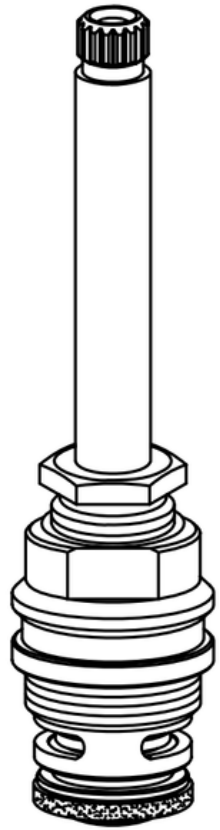

SAVOY 4-3/8"
DIVERETER

W61971

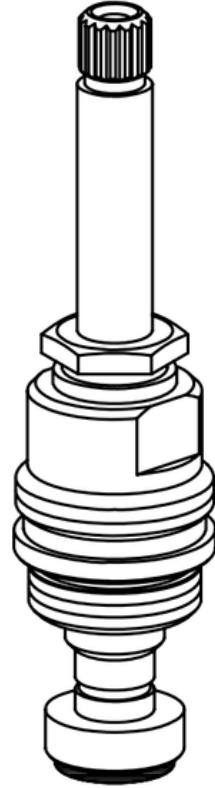

SAVOY 4"
HOT/COLD

W61980

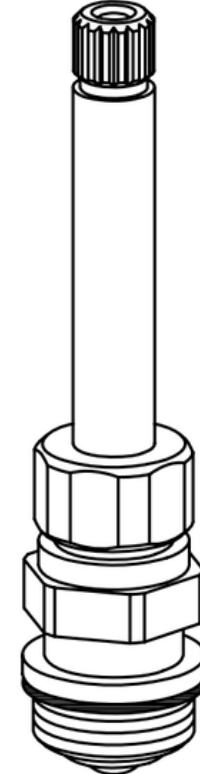

STERLING 3-7/8"
HOT/COLD

W61970

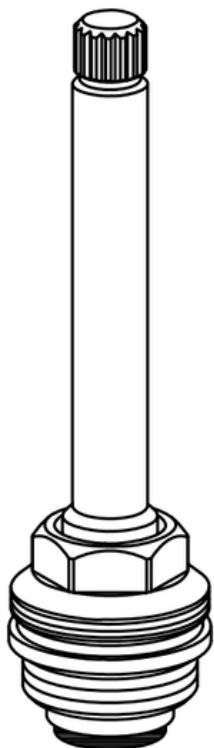

SAVOY 3-13/16"
HOT/COLD

W61972

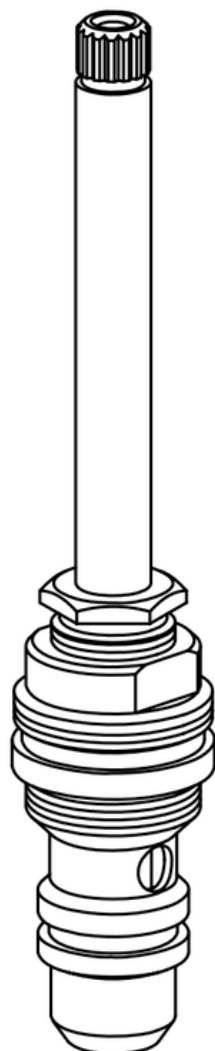

SAVOY 5-5/16"
DIVERETER

W61981

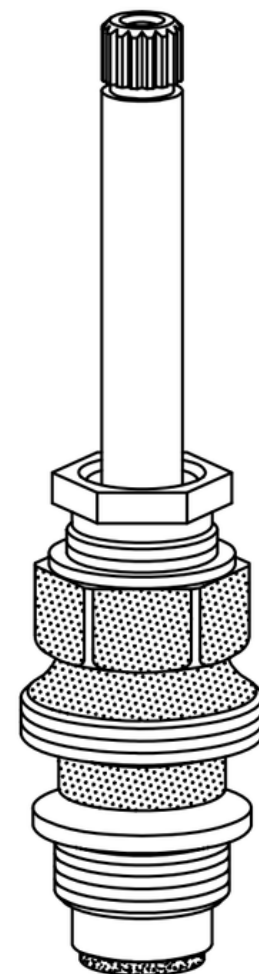

STERLING 4-11/16"
HOT/COLD

W61982

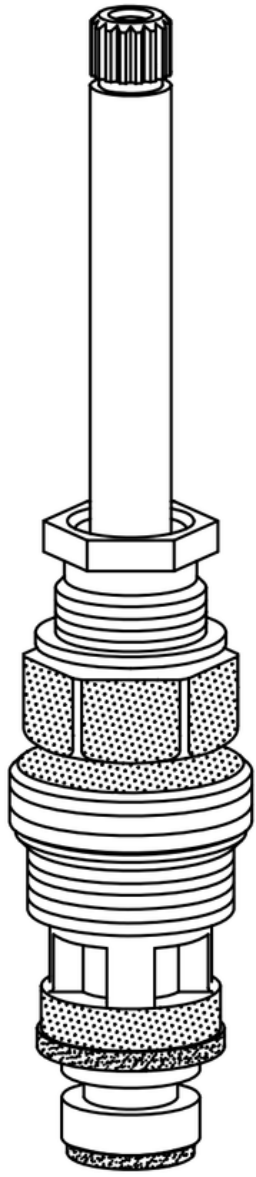

STERLING 4-5/8"
DIVERTER

W61984

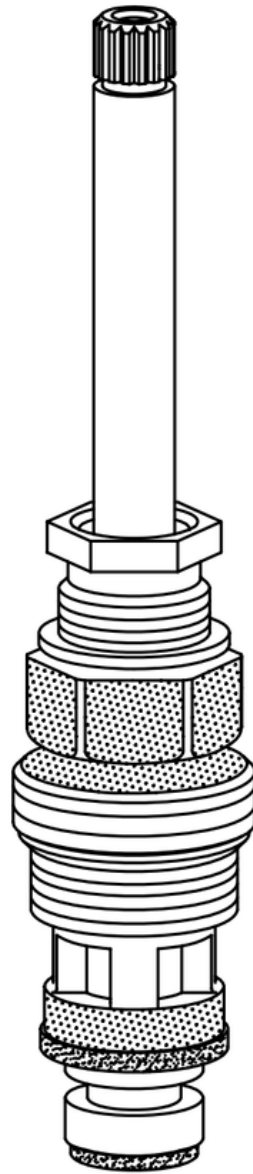

STERLING 5-5/8"
DIVERTER
WITH C.P(1)

W61986

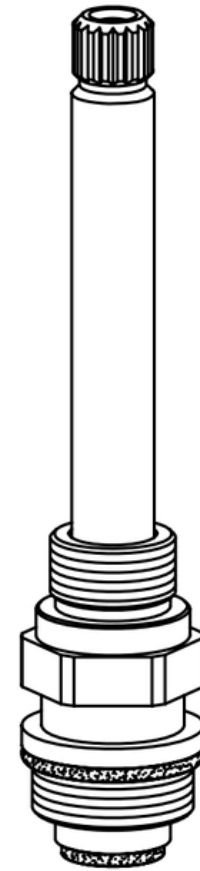

STERLING 4-3/8"
HOT/COLD

W61983

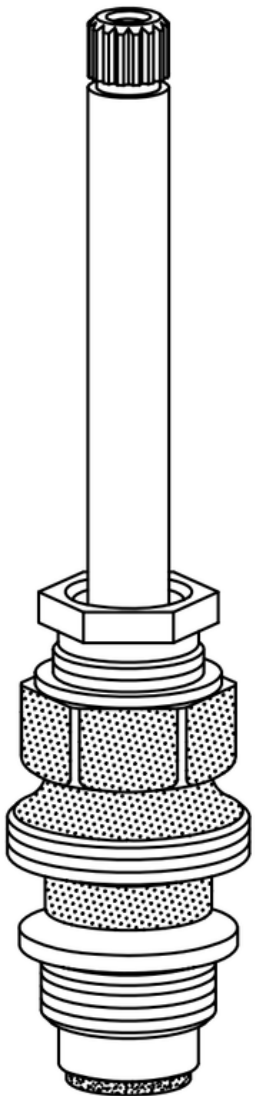

STERLING 5-3/8"
HOT/COLD
WITH C.P(1)

W61985

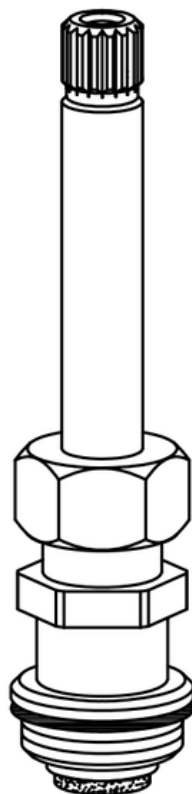

STERLING 3-13/16"
HOT/COLD

W61987

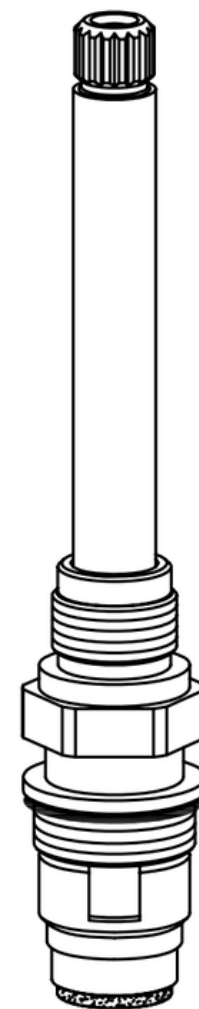

STERLING 5"
DIVERTER

W61989

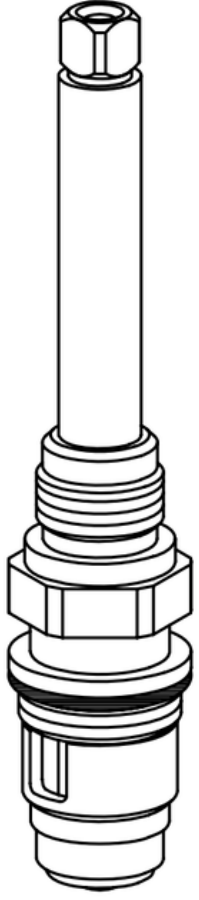

STERLING 5"
DIVERTER

W61991

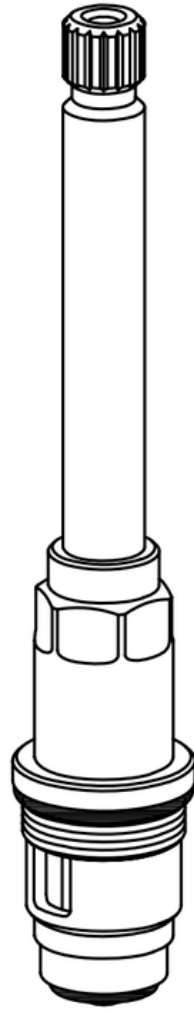

STERLING 5"
DIVERTER

W61994

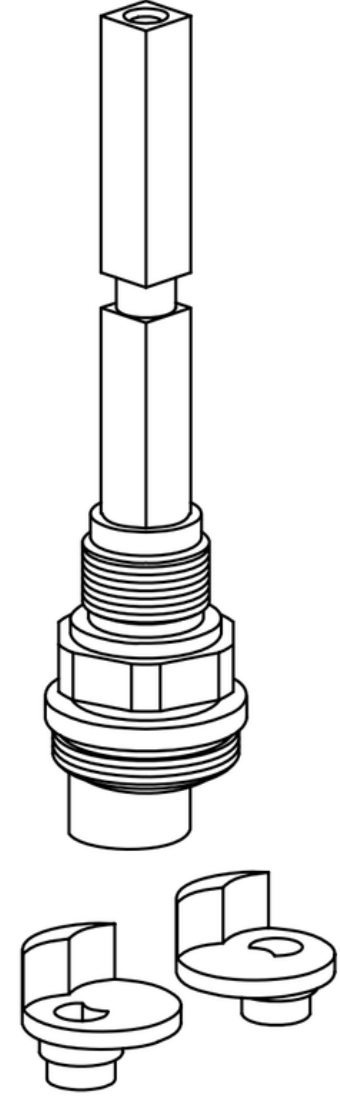

STERLING 4-1/4"
HOT/COLD

W61990

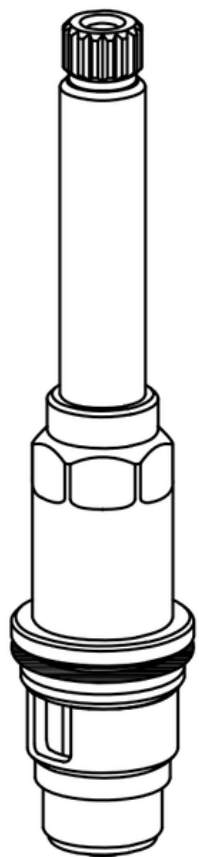

STERLING 4-1/2"
DIVERTER

W61992

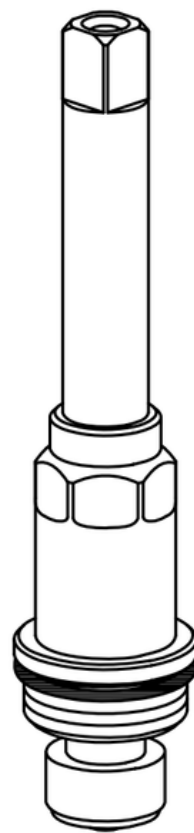

STERLING 4"
HOT/COLD

W61995

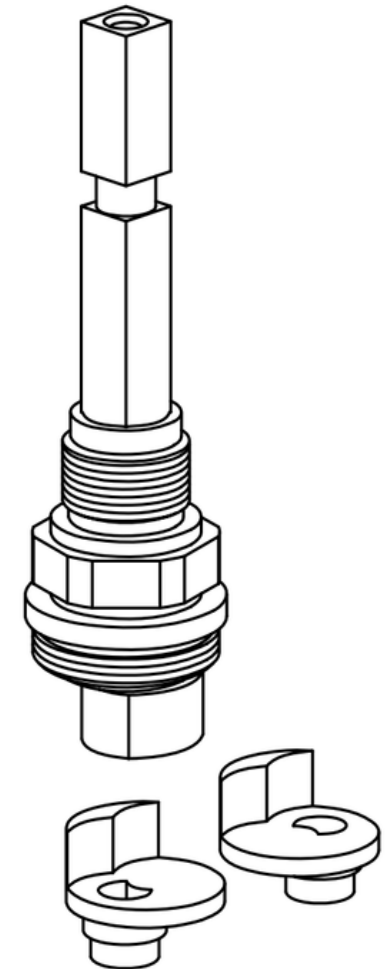

STERLING 3-23/32"
HOT/COLD

W61996



16 PT.

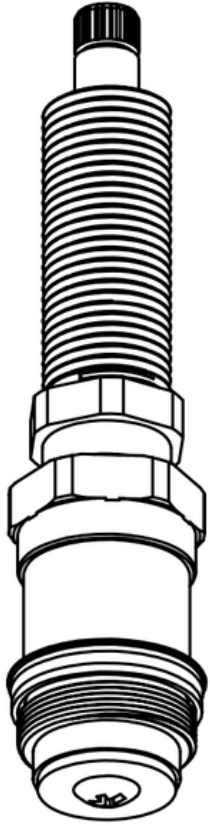

STERLING
HOT/COLD

W62110



18 PT.

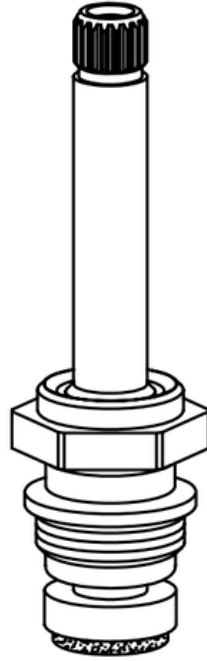

UNION 3-1/4"
HOT

W62112



18 PT.

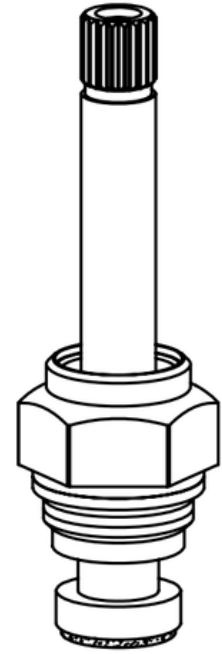

UNION 3-1/4"
HOT

W61997



12 PT.

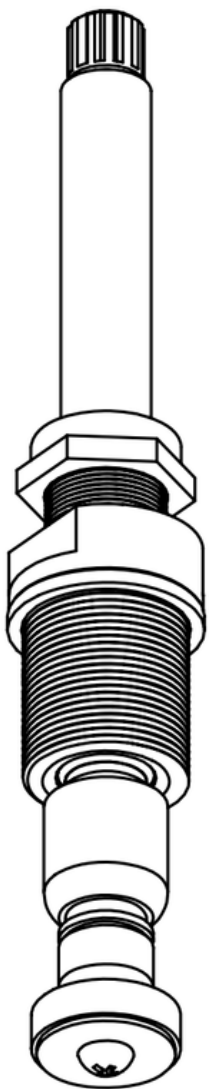

SCOVILL
HOT C.P (1)

W62111



18 PT.

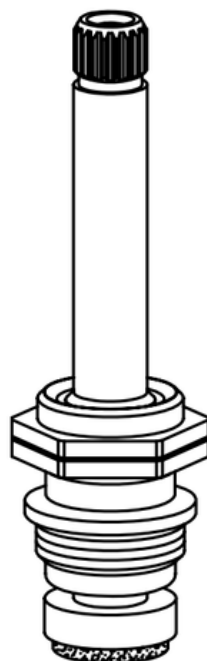

UNION 3-1/4"
COLD

W62113



18 PT.

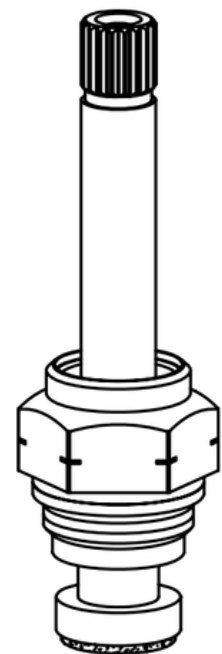

UNION 3-1/4"
COLD

W62114

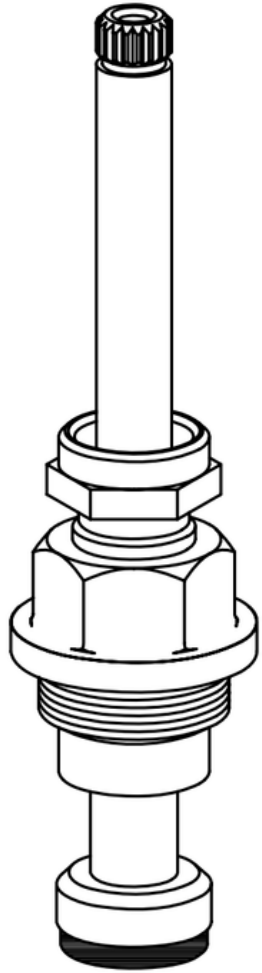

UNION 4-29/32"
HOT/COLD

W62117

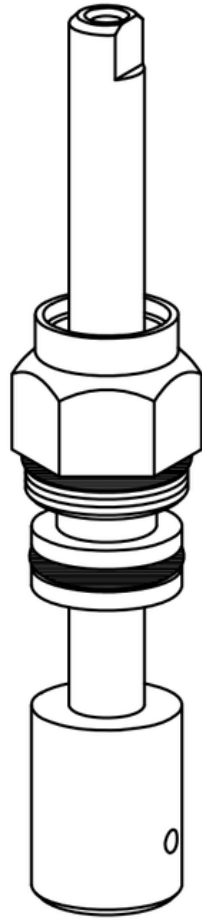

UNION BRASS 4-5/8"
DIVERTER

W62119

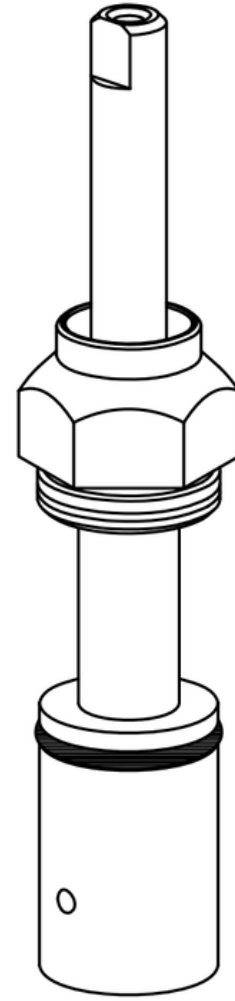

UNION BRASS 4-3/4"
DIVERTER

W62116

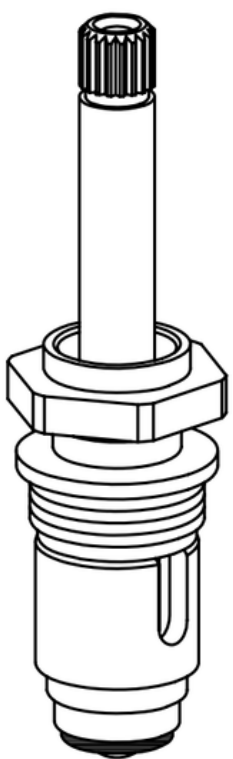

UNION 3-3/4"
DIVERTER

W62118

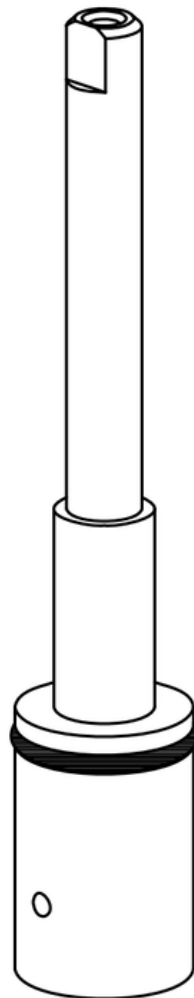

UNION BRASS 4-3/4"
DIVERTER

W62205

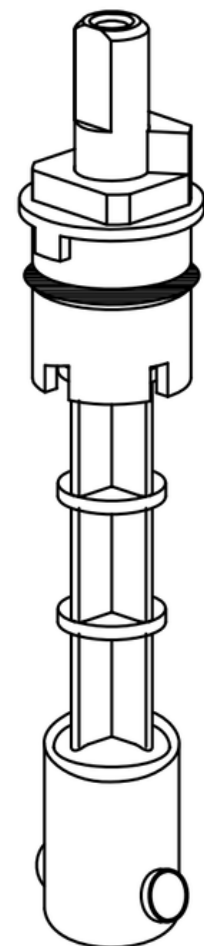

PLASTIC

VALLEY 4-3/4"
DIVERTER

W62211

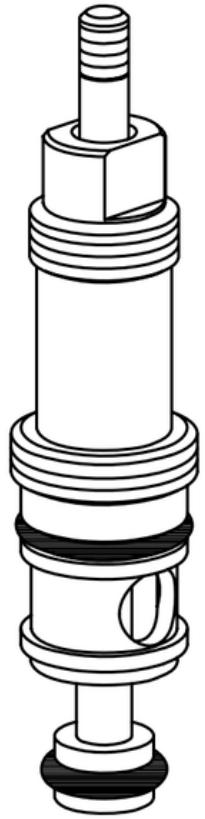

WALTEC 4-1/8"
WITH C.P

W62214



16 PT.

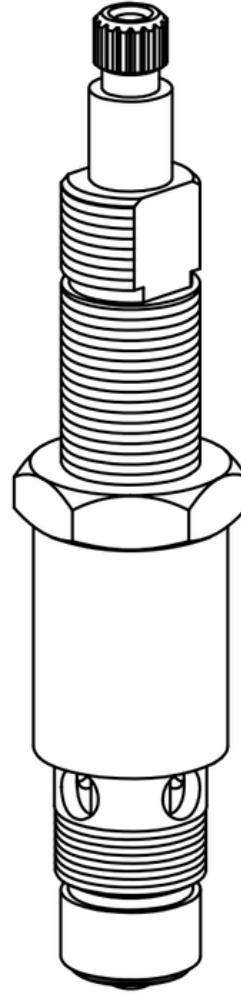

WALLACEBURG 5"
DIVERTER

W62341



12 PT.

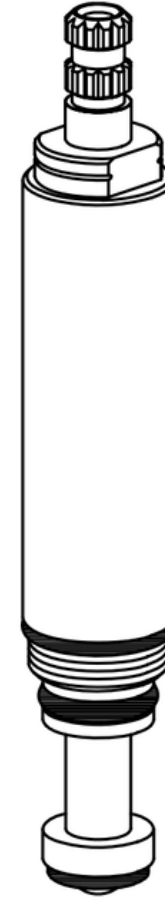

WOLVERINE 4-1/2"
COLD
WITH C.P (2)

W62213



16 PT.

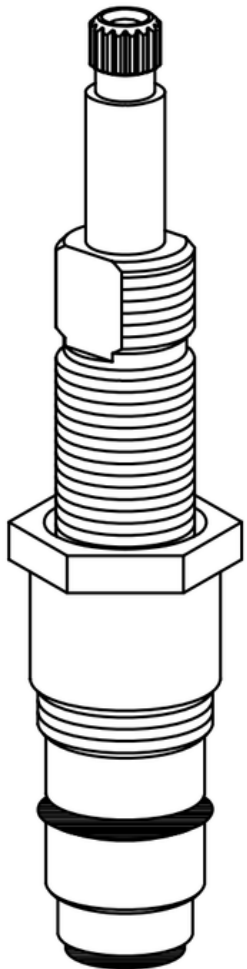

WALLACEBURG 4-7/8"
HOT/COLD

W62340



12 PT.

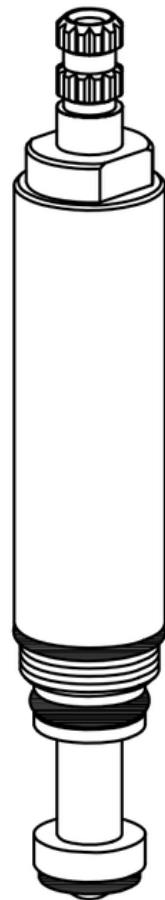

WOLVERINE 4-1/2"
HOT
WITH C.P (2)

W62342

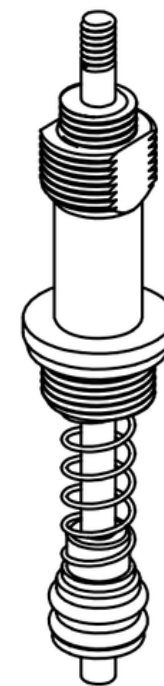

DIVERTER
WITH N.P (1)